

PHILIPPINE BIDDING DOCUMENTS

CONSTRUCTION OF CSIS OFFICE AT PLARIDEL AIRPORT (Bid No. PL-POI-01-2022)

Government of the Republic of the Philippines

Sixth Edition
July 2020

Preface

These Philippine Bidding Documents (PBDs) for the procurement of Infrastructure Projects (hereinafter referred to also as the “Works”) through Competitive Bidding have been prepared by the Government of the Philippines for use by all branches, agencies, departments, bureaus, offices, or instrumentalities of the government, including government-owned and/or -controlled corporations, government financial institutions, state universities and colleges, local government units, and autonomous regional government. The procedures and practices presented in this document have been developed through broad experience, and are for mandatory use in projects that are financed in whole or in part by the Government of the Philippines or any foreign government/foreign or international financing institution in accordance with the provisions of the 2016 revised Implementing Rules and Regulations (IRR) of Republic Act (RA) No. 9184.

The PBDs are intended as a model for admeasurements (unit prices or unit rates in a bill of quantities) types of contract, which are the most common in Works contracting.

The Bidding Documents shall clearly and adequately define, among others: (i) the objectives, scope, and expected outputs and/or results of the proposed contract; (ii) the eligibility requirements of Bidders; (iii) the expected contract duration; and (iv) the obligations, duties, and/or functions of the winning Bidder.

Care should be taken to check the relevance of the provisions of the PBDs against the requirements of the specific Works to be procured. If duplication of a subject is inevitable in other sections of the document prepared by the Procuring Entity, care must be exercised to avoid contradictions between clauses dealing with the same matter.

Moreover, each section is prepared with notes intended only as information for the Procuring Entity or the person drafting the Bidding Documents. They shall not be included in the final documents. The following general directions should be observed when using the documents:

- a. All the documents listed in the Table of Contents are normally required for the procurement of Infrastructure Projects. However, they should be adapted as necessary to the circumstances of the particular Project.
- b. Specific details, such as the “*name of the Procuring Entity*” and “*address for bid submission*,” should be furnished in the Instructions to Bidders, Bid Data Sheet, and Special Conditions of Contract. The final documents should contain neither blank spaces nor options.
- c. This Preface and the footnotes or notes in italics included in the Invitation to Bid, BDS, General Conditions of Contract, Special Conditions of Contract, Specifications, Drawings, and Bill of Quantities are not part of the text of the final document, although they contain instructions that the Procuring Entity should strictly follow.
- d. The cover should be modified as required to identify the Bidding Documents as to the names of the Project, Contract, and Procuring Entity, in addition to date of issue.

- e. Modifications for specific Procurement Project details should be provided in the Special Conditions of Contract as amendments to the Conditions of Contract. For easy completion, whenever reference has to be made to specific clauses in the Bid Data Sheet or Special Conditions of Contract, these terms shall be printed in bold typeface on Sections I (Instructions to Bidders) and III (General Conditions of Contract), respectively.
- f. For guidelines on the use of Bidding Forms and the procurement of Foreign-Assisted Projects, these will be covered by a separate issuance of the Government Procurement Policy Board.

TABLE OF CONTENTS

GLOSSARY OF	5
TERMS, ABBREVIATIONS, AND ACRONYMS	5
SECTION I. INVITATION TO BID	8
SECTION II. INSTRUCTIONS TO BIDDERS.....	11
1. Scope of Bid.....	12
2. Funding Information	12
3. Bidding Requirements.....	12
4. Corrupt, Fraudulent, Collusive, Coercive, and Obstructive Practices	12
5. Eligible Bidders.....	13
6. Origin of Associated Goods	13
7. Subcontracts	13
8. Pre-Bid Conference.....	14
9. Clarification and Amendment of Bidding Documents	14
10. Documents Comprising the Bid: Eligibility and Technical Components.....	14
11. Documents Comprising the Bid: Financial Component	15
12. Alternative Bids	15
13. Bid Prices	15
14. Bid and Payment Currencies.....	15
15. Bid Security.....	15
16. Sealing and Marking of Bids.....	16
17. Deadline for Submission of Bids	16
18. Opening and Preliminary Examination of Bids	16
19. Detailed Evaluation and Comparison of Bids.....	16
20. Post Qualification.....	17
21. Signing of the Contract	17
SECTION III. BID DATA SHEET	18
SECTION IV. GENERAL CONDITIONS OF CONTRACT	25
1. Scope of Contract.....	26
2. Sectional Completion of Works	26
3. Possession of Site.....	26
4. The Contractor's Obligations.....	26

5.	Performance Security	27
6.	Site Investigation Reports	27
7.	Warranty.....	27
8.	Liability of the Contractor.....	27
9.	Termination for Other Causes	27
10.	Dayworks	28
11.	Program of Work.....	28
12.	Instructions, Inspections and Audits	28
13.	Advance Payment.....	28
14.	Progress Payments	28
15.	Operating and Maintenance Manuals.....	29
SECTION V. SPECIAL CONDITIONS OF CONTRACT.....		30
SECTION VI. SPECIFICATIONS		32
SECTION VII. DRAWINGS.....		40
SECTION VIII. BILL OF QUANTITIES.....		46
SECTION IX. BIDDING FORMS		61
SECTION X. CHECKLIST OF TECHNICAL AND FINANCIAL DOCUMENTS		98

Glossary of Terms, Abbreviations, and Acronyms

ABC – Approved Budget for the Contract.

ARCC – Allowable Range of Contract Cost.

BAC – Bids and Awards Committee.

Bid – A signed offer or proposal to undertake a contract submitted by a bidder in response to and in consonance with the requirements of the bidding documents. Also referred to as *Proposal* and *Tender*. (2016 revised IRR, Section 5[c])

Bidder – Refers to a contractor, manufacturer, supplier, distributor and/or consultant who submits a bid in response to the requirements of the Bidding Documents. (2016 revised IRR, Section 5[d])

Bidding Documents – The documents issued by the Procuring Entity as the bases for bids, furnishing all information necessary for a prospective bidder to prepare a bid for the Goods, Infrastructure Projects, and/or Consulting Services required by the Procuring Entity. (2016 revised IRR, Section 5[e])

BIR – Bureau of Internal Revenue.

BSP – Bangko Sentral ng Pilipinas.

CDA – Cooperative Development Authority.

Consulting Services – Refer to services for Infrastructure Projects and other types of projects or activities of the GOP requiring adequate external technical and professional expertise that are beyond the capability and/or capacity of the GOP to undertake such as, but not limited to: (i) advisory and review services; (ii) pre-investment or feasibility studies; (iii) design; (iv) construction supervision; (v) management and related services; and (vi) other technical services or special studies. (2016 revised IRR, Section 5[i])

Contract – Refers to the agreement entered into between the Procuring Entity and the Supplier or Manufacturer or Distributor or Service Provider for procurement of Goods and Services; Contractor for Procurement of Infrastructure Projects; or Consultant or Consulting Firm for Procurement of Consulting Services; as the case may be, as recorded in the Contract Form signed by the parties, including all attachments and appendices thereto and all documents incorporated by reference therein.

Contractor – is a natural or juridical entity whose proposal was accepted by the Procuring Entity and to whom the Contract to execute the Work was awarded. Contractor as used in these Bidding Documents may likewise refer to a supplier, distributor, manufacturer, or consultant.

CPI – Consumer Price Index.

DOLE – Department of Labor and Employment.

DTI – Department of Trade and Industry.

Foreign-funded Procurement or Foreign-Assisted Project –Refers to procurement whose funding source is from a foreign government, foreign or international financing institution as specified in the Treaty or International or Executive Agreement. (2016 revised IRR, Section 5[b]).

GFI – Government Financial Institution.

GOCC –Government-owned and/or –controlled corporation.

Goods – Refer to all items, supplies, materials and general support services, except Consulting Services and Infrastructure Projects, which may be needed in the transaction of public businesses or in the pursuit of any government undertaking, project or activity, whether in the nature of equipment, furniture, stationery, materials for construction, or personal property of any kind, including non-personal or contractual services such as the repair and maintenance of equipment and furniture, as well as trucking, hauling, janitorial, security, and related or analogous services, as well as procurement of materials and supplies provided by the Procuring Entity for such services. The term “related” or “analogous services” shall include, but is not limited to, lease or purchase of office space, media advertisements, health maintenance services, and other services essential to the operation of the Procuring Entity. (2016 revised IRR, Section 5[r])

GOP – Government of the Philippines.

Infrastructure Projects – Include the construction, improvement, rehabilitation, demolition, repair, restoration or maintenance of roads and bridges, railways, airports, seaports, communication facilities, civil works components of information technology projects, irrigation, flood control and drainage, water supply, sanitation, sewerage and solid waste management systems, shore protection, energy/power and electrification facilities, national buildings, school buildings, hospital buildings, and other related construction projects of the government. Also referred to as *civil works or works*. (2016 revised IRR, Section 5[u])

LGUs – Local Government Units.

NFCC – Net Financial Contracting Capacity.

NGA – National Government Agency.

PCAB – Philippine Contractors Accreditation Board.

PhilGEPS - Philippine Government Electronic Procurement System.

Procurement Project – refers to a specific or identified procurement covering goods, infrastructure project or consulting services. A Procurement Project shall be described, detailed, and scheduled in the Project Procurement Management Plan prepared by the agency which shall be consolidated in the procuring entity's Annual Procurement Plan. (GPPB Circular No. 06-2019 dated 17 July 2019)

PSA – Philippine Statistics Authority.

SEC – Securities and Exchange Commission.

SLCC – Single Largest Completed Contract.

UN – United Nations.

Section I. Invitation to Bid

Notes on the Invitation to Bid

The Invitation to Bid (IB) provides information that enables potential Bidders to decide whether to participate in the procurement at hand. The IB shall be posted in accordance with Section 21.2 of the 2016 revised IRR of RA No. 9184.

Apart from the essential items listed in the Bidding Documents, the IB should also indicate the following:

- a. The date of availability of the Bidding Documents, which shall be from the time the IB is first advertised/posted until the deadline for the submission and receipt of bids;
- b. The place where the Bidding Documents may be acquired or the website where it may be downloaded;
- c. The deadline for the submission and receipt of bids; and
- d. Any important bid evaluation criteria.

The IB should be incorporated into the Bidding Documents. The information contained in the IB must conform to the Bidding Documents and in particular to the relevant information in the Bid Data Sheet.



Invitation to Bid for Construction of CSIS Office at Plaridel Airport Bid No. PL-POI-01-2022

1. The Civil Aviation Authority of the Philippines, through the CAAP Corporate Budget CY 2022 intends to apply the sum of **TWO MILLION SIXTY TWO THOUSAND FIVE HUNDRED PESOS (P2,062,500.00)** being the Approved Budget for the Contract (ABC) to payments under the contract for **CONSTRUCTION OF CSIS OFFICE AT PLARIDEL AIRPORT Bid No. PL-POI-01-2022**. Bids received in excess of the ABC shall be automatically rejected at bid opening.
2. The Civil Aviation Authority of the Philippines now invites bids for the above Procurement Project. Completion of the Works is required **Ninety (90) Calendar Days (inclusive of Nine (9) rainy/unworkable days)**. Bidders should have completed a contract similar to the Project. The description of an eligible bidder is contained in the Bidding Documents, particularly, in Section II (Instructions to Bidders).
3. Bidding will be conducted through open competitive bidding procedures using non-discretionary “*pass/fail*” criterion as specified in the 2016 revised Implementing Rules and Regulations (IRR) of Republic Act (RA) No. 9184.
4. Interested bidders may obtain further information from Civil Aviation Authority of the Philippines, Plaridel Bulacan and inspect the Bidding Documents at the address given below from 8am – 5pm MONDAY to FRIDAY.
5. A complete set of Bidding Documents may be acquired by interested bidders on *September 6, 2022* from given address and website/s below and upon payment of the applicable fee for the Bidding Documents, pursuant to the latest Guidelines issued by the GPPB, in the amount of five thousand pesos (Php 5,000.00) (*exclusive of tax*). The Procuring Entity shall allow the bidder to present its proof of payment for the fees in person, by facsimile, or through electronic means.
6. The Civil Aviation Authority of the Philippines will hold a Pre-Bid Conference¹ on *September 13, 2022, 10:00am* at Plaridel, Bulacan and/or through videoconferencing/webcasting *via Zoom*, which shall be open to prospective bidders.
7. Bids must be duly received by the BAC Secretariat through manual submission at the office address as indicated below on or before *September 27, 2022, 9:00am*. Late bids shall not be accepted.

¹ May be deleted in case the ABC is less than One Million Pesos (PhP1,000,000) where the Procuring Entity may not hold a pre-bid conference.



8. All bids must be accompanied by a bid security in any of the acceptable forms and in the amount stated in **ITB** Clause 16.
9. Bid opening shall be on *September 27, 2022, 10:00am* at the given address below. Bids will be opened in the presence of the bidders' representatives who choose to attend the activity.
10. The Civil Aviation Authority of the Philippines reserves the right to reject any and all bids, declare a failure of bidding, or not award the contract at any time prior to contract award in accordance with Sections 35.6 and 41 of the 2016 revised Implementing Rules and Regulations (IRR) of RA No. 9184, without thereby incurring any liability to the affected bidder or bidders.
11. For further information, please refer to:

MICHAEL LOUIE ANGELO I. RODRIGUEZ
BAC Secretariat Head
CIVIL AVIATION AUTHORITY OF THE PHILIPPINES
0385 Lumang Bayan, Plaridel Airport, Plaridel Bulacan
Email: areacenter3_bac@caap.gov.ph
Tel No.: 044-794-7071

12. You may visit the following websites:

For downloading of Bidding Documents: *www.caap.gov.ph*

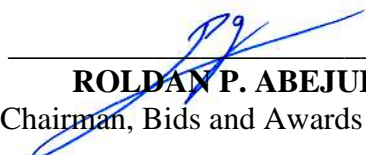

ROLDAN P. ABEJUELA
Chairman, Bids and Awards Committee



Section II. Instructions to Bidders

Notes on the Instructions to Bidders

This Section on the Instruction to Bidders (ITB) provides the information necessary for bidders to prepare responsive bids, in accordance with the requirements of the Procuring Entity. It also provides information on bid submission, eligibility check, opening and evaluation of bids, post-qualification, and on the award of contract.



1. Scope of Bid

The Procuring Entity, Civil Aviation Authority of the Philippines invites Bids for the Construction of CSIS Office at Plaridel Airport, with Project Identification Number Bid No. PL-POI-01-2022.

The Procurement Project (referred to herein as “Project”) is for the construction of Works, as described in Section VI (Specifications).

2. Funding Information

2.1. The GOP through the source of funding as indicated below for CAAP Corporate Budget CY 2022 in the amount of **TWO MILLION SIXTY TWO THOUSAND FIVE HUNDRED PESOS (P2,062,500.00)**.

2.2. The source of funding is GOCC’s, the Corporate Operating Budget.

3. Bidding Requirements

The Bidding for the Project shall be governed by all the provisions of RA No. 9184 and its 2016 revised IRR, including its Generic Procurement Manual and associated policies, rules and regulations as the primary source thereof, while the herein clauses shall serve as the secondary source thereof.

Any amendments made to the IRR and other GPPB issuances shall be applicable only to the ongoing posting, advertisement, or invitation to bid by the BAC through the issuance of a supplemental or bid bulletin.

The Bidder, by the act of submitting its Bid, shall be deemed to have inspected the site, determined the general characteristics of the contracted Works and the conditions for this Project, such as the location and the nature of the work; (b) climatic conditions; (c) transportation facilities; (c) nature and condition of the terrain, geological conditions at the site communication facilities, requirements, location and availability of construction aggregates and other materials, labor, water, electric power and access roads; and (d) other factors that may affect the cost, duration and execution or implementation of the contract, project, or work and examine all instructions, forms, terms, and project requirements in the Bidding Documents.

4. Corrupt, Fraudulent, Collusive, Coercive, and Obstructive Practices

The Procuring Entity, as well as the Bidders and Contractors, shall observe the highest standard of ethics during the procurement and execution of the contract. They or through an agent shall not engage in corrupt, fraudulent, collusive, coercive, and obstructive practices defined under Annex “I” of the 2016 revised IRR of RA No. 9184 or other integrity violations in competing for the Project.



5. Eligible Bidders

- 5.1. Only Bids of Bidders found to be legally, technically, and financially capable will be evaluated.
- 5.2. The Bidder must have an experience of having completed a Single Largest Completed Contract (SLCC) that is similar to this Project, equivalent to at least fifty percent (50%) of the ABC adjusted, if necessary, by the Bidder to current prices using the PSA's CPI, except under conditions provided for in Section 23.4.2.4 of the 2016 revised IRR of RA No. 9184.

A contract is considered to be “similar” to the contract to be bid if it has the major categories of work stated in the **BDS**.

- 5.3. For Foreign-funded Procurement, the Procuring Entity and the foreign government/foreign or international financing institution may agree on another track record requirement, as specified in the Bidding Document prepared for this purpose.
- 5.4. The Bidders shall comply with the eligibility criteria under Section 23.4.2 of the 2016 IRR of RA No. 9184.

6. Origin of Associated Goods

There is no restriction on the origin of Goods other than those prohibited by a decision of the UN Security Council taken under Chapter VII of the Charter of the UN.

7. Subcontracts

- 7.1. The Bidder may subcontract portions of the Project to the extent allowed by the Procuring Entity as stated herein, but in no case more than fifty percent (50%) of the Project.

The Procuring Entity has prescribed that:

- a. Subcontracting is not allowed.



8. Pre-Bid Conference

The Procuring Entity will hold a pre-bid conference for this Project on the specified date and time and either at its physical address and/or through videoconferencing/webcasting as indicated in paragraph 6 of the **IB**.

9. Clarification and Amendment of Bidding Documents

Prospective bidders may request for clarification on and/or interpretation of any part of the Bidding Documents. Such requests must be in writing and received by the Procuring Entity, either at its given address or through electronic mail indicated in the **IB**, at least ten (10) calendar days before the deadline set for the submission and receipt of Bids.

10. Documents Comprising the Bid: Eligibility and Technical Components

- 10.1. The first envelope shall contain the eligibility and technical documents of the Bid as specified in **Section IX. Checklist of Technical and Financial Documents**.
- 10.2. If the eligibility requirements or statements, the bids, and all other documents for submission to the BAC are in foreign language other than English, it must be accompanied by a translation in English, which shall be authenticated by the appropriate Philippine foreign service establishment, post, or the equivalent office having jurisdiction over the foreign bidder's affairs in the Philippines. For Contracting Parties to the Apostille Convention, only the translated documents shall be authenticated through an apostille pursuant to GPPB Resolution No. 13-2019 dated 23 May 2019. The English translation shall govern, for purposes of interpretation of the bid.
- 10.3. A valid PCAB License is required, and in case of joint ventures, a valid special PCAB License, and registration for the type and cost of the contract for this Project. Any additional type of Contractor license or permit shall be indicated in the **BDS**.
- 10.4. A List of Contractor's key personnel (e.g., Project Manager, Project Engineers, Materials Engineers, and Foremen) assigned to the contract to be bid, with their complete qualification and experience data shall be provided. These key personnel must meet the required minimum years of experience set in the **BDS**.
- 10.5. A List of Contractor's major equipment units, which are owned, leased, and/or under purchase agreements, supported by proof of ownership, certification of availability of equipment from the equipment lessor/vendor for the duration of the project, as the case may be, must meet the minimum requirements for the contract set in the **BDS**.



11. Documents Comprising the Bid: Financial Component

- 11.1. The second bid envelope shall contain the financial documents for the Bid as specified in **Section IX. Checklist of Technical and Financial Documents**.
- 11.2. Any bid exceeding the ABC indicated in paragraph 1 of the **IB** shall not be accepted.
- 11.3. For Foreign-funded procurement, a ceiling may be applied to bid prices provided the conditions are met under Section 31.2 of the 2016 revised IRR of RA No. 9184.

12. Alternative Bids

Bidders shall submit offers that comply with the requirements of the Bidding Documents, including the basic technical design as indicated in the drawings and specifications. Unless there is a value engineering clause in the **BDS**, alternative Bids shall not be accepted.

13. Bid Prices

All bid prices for the given scope of work in the Project as awarded shall be considered as fixed prices, and therefore not subject to price escalation during contract implementation, except under extraordinary circumstances as determined by the NEDA and approved by the GPPB pursuant to the revised Guidelines for Contract Price Escalation guidelines.

14. Bid and Payment Currencies

- 14.1. Bid prices may be quoted in the local currency or tradeable currency accepted by the BSP at the discretion of the Bidder. However, for purposes of bid evaluation, Bids denominated in foreign currencies shall be converted to Philippine currency based on the exchange rate as published in the BSP reference rate bulletin on the day of the bid opening.
- 14.2. Payment of the contract price shall be made in:
 - a. Philippine Pesos.

15. Bid Security

- 15.1. The Bidder shall submit a Bid Securing Declaration or any form of Bid Security in the amount indicated in the **BDS**, which shall be not less than the percentage of the ABC in accordance with the schedule in the **BDS**.



- 15.2. The Bid and bid security shall be valid until December 31, 2022. Any bid not accompanied by an acceptable bid security shall be rejected by the Procuring Entity as non-responsive.

16. Sealing and Marking of Bids

Each Bidder shall submit one copy of the first and second components of its Bid.

The Procuring Entity may request additional hard copies and/or electronic copies of the Bid. However, failure of the Bidders to comply with the said request shall not be a ground for disqualification.

If the Procuring Entity allows the submission of bids through online submission to the given website or any other electronic means, the Bidder shall submit an electronic copy of its Bid, which must be digitally signed. An electronic copy that cannot be opened or is corrupted shall be considered non-responsive and, thus, automatically disqualified.

17. Deadline for Submission of Bids

The Bidders shall submit on the specified date and time and either at its physical address or through online submission as indicated in paragraph 7 of the **IB**.

18. Opening and Preliminary Examination of Bids

- 18.1. The BAC shall open the Bids in public at the time, on the date, and at the place specified in paragraph 9 of the **IB**. The Bidders' representatives who are present shall sign a register evidencing their attendance. In case videoconferencing, webcasting or other similar technologies will be used, attendance of participants shall likewise be recorded by the BAC Secretariat.

In case the Bids cannot be opened as scheduled due to justifiable reasons, the rescheduling requirements under Section 29 of the 2016 revised IRR of RA No. 9184 shall prevail.

- 18.2. The preliminary examination of Bids shall be governed by Section 30 of the 2016 revised IRR of RA No. 9184.

19. Detailed Evaluation and Comparison of Bids

- 19.1. The Procuring Entity's BAC shall immediately conduct a detailed evaluation of all Bids rated "*passed*" using non-discretionary pass/fail criteria. The BAC shall consider the conditions in the evaluation of Bids under Section 32.2 of 2016 revised IRR of RA No. 9184.



- 19.2. If the Project allows partial bids, all Bids and combinations of Bids as indicated in the **BDS** shall be received by the same deadline and opened and evaluated simultaneously so as to determine the Bid or combination of Bids offering the lowest calculated cost to the Procuring Entity. Bid Security as required by **ITB** Clause 15 shall be submitted for each contract (lot) separately.
- 19.3. In all cases, the NFCC computation pursuant to Section 23.4.2.6 of the 2016 revised IRR of RA No. 9184 must be sufficient for the total of the ABCs for all the lots participated in by the prospective Bidder.

20. Post Qualification

Within a non-extendible period of five (5) calendar days from receipt by the Bidder of the notice from the BAC that it submitted the Lowest Calculated Bid, the Bidder shall submit its latest income and business tax returns filed and paid through the BIR Electronic Filing and Payment System (eFPS), and other appropriate licenses and permits required by law and stated in the **BDS**.

21. Signing of the Contract

The documents required in Section 37.2 of the 2016 revised IRR of RA No. 9184 shall form part of the Contract. Additional Contract documents are indicated in the **BDS**.

Section III. Bid Data Sheet

Notes on the Bid Data Sheet (BDS)

The Bid Data Sheet (BDS) consists of provisions that supplement, amend, or specify in detail, information, or requirements included in the ITB found in Section II, which are specific to each procurement.

This Section is intended to assist the Procuring Entity in providing the specific information in relation to corresponding clauses in the ITB and has to be prepared for each specific procurement.

The Procuring Entity should specify in the BDS information and requirements specific to the circumstances of the Procuring Entity, the processing of the procurement, and the bid evaluation criteria that will apply to the Bids. In preparing the BDS, the following aspects should be checked:

- a. Information that specifies and complements provisions of the ITB must be incorporated.
- b. Amendments and/or supplements, if any, to provisions of the ITB as necessitated by the circumstances of the specific procurement, must also be incorporated.

Bid Data Sheet

ITB Clause	
3.0	<p>Certificate of Site Inspection (<i>Annex “B” Form I</i>) duly signed by Mr. Glenn D. Tripulca, Acting Area Manager of Area III or his duly authorized representative, is required to be submitted.</p> <p>This shall include all of the following documents as attachment to the Certificate of Site Inspection and shall form part of the bidder’s technical documents:</p> <ul style="list-style-type: none"> a) Copy of company ID of the person who conducted the site inspection; b) Copy of the airport/facility visitor’s logbook;& c) Picture of the proposed site including the personnel who conducted the site inspection together with the Airport Manager/Officer in Charge or his duly authorized representative. <p>Bids not complying with the above instruction shall be disqualified.</p>
5.2	<p>For this purpose, contracts similar to the Project refer to contracts which have the same major categories of work, which shall be:</p> <p>“Building Construction/Improvement/ Rehabilitation/ Repair” or</p>
7.1	<p>Subcontracting is not allowed.</p>
10. 1	<p>Bidder shall submit all eligibility and technical documents as specified in Section X. Checklist of Technical and Financial Documents:</p> <p>Class “A” Documents <u>Legal Documents</u></p> <ul style="list-style-type: none"> a. Valid PhilGEPS Registration Certificate (Platinum Membership) (all pages);or b. Registration certificate from Securities and Exchange Commission (SEC), Department of Trade and Industry (DTI) for sole proprietorship, or Cooperative Development Authority (CDA) for cooperatives or its equivalent document; and c. Mayor’s or Business permit issued by the city or municipality where the principal place of business of the prospective bidder is located, or the equivalent document for Exclusive Economic Zones or Areas; and d. Tax clearance per E.O. No. 398, s. 2005, as finally reviewed and approved by the Bureau of Internal Revenue (BIR); and <p><i>In connection to GPPB Circular 07-2017 dated 31 July 2017, the bidder shall have the following options:</i></p>

Submit the Certificate of PhilGEPS Registration and Platinum Membership including its Annex "A" in lieu of the uploaded Class "A" Eligibility Documents identified in Section 8.5.2 of the Revised Implementing Rules and Regulations of Republic Act 9184 (Revised IRR of RA 9184), provided that all Class "A" Eligibility Documents listed under the aforesaid Annex "A" are all uploaded and maintained current and updated in the PhilGEPS Registry.

2. *Submit a combination of the PhilGEPS Registration and Platinum Membership including its Annex "A" and Class "A" Eligibility Documents identified in Section 8.5.2 of the Revised IRR of RA9184.*
 - *In the event that aforesaid Class "A" Eligibility Document(s) listed in the Annex "A" of the PhilGEPS Registration and Platinum Membership is/are reflected to be outdated, the bidder shall submit such current and updated Class "A" Eligibility Document(s).*
3. *Submit all the Class "A" Eligibility Documents only, provided that the PhilGEPS Registration and Platinum Membership shall be submitted as a Post-Qualification requirement in accordance with Section 34.2 of the Revised IRR of RA9184.*

Technical Documents

- e. Statement of the prospective bidder of all its ongoing government and private contracts, including contracts awarded but not yet started, if any, whether similar or not similar in nature and complexity to the contract to be bid. (*Annex "A" Form 1*); and
- f. Statement of the bidder's Single Largest Completed Contract (SLCC) similar to the contract to be bid, except under conditions provided under the rules. (*Annex "A" Form 2*); and
- g. Philippine Contractors Accreditation Board (PCAB) License; or Special PCAB License in case of Joint Ventures; and registration for the type and cost of the contract to be bid; and Joint Resolution (*Annex "A" Form 3*); and
- h. Original copy of Bid Security. If in the form of a Surety Bond, submit also a certification issued by the Insurance Commission; or Original copy of Notarized Bid Securing Declaration (*Annex "B" Form 2*); and
- i. Project Requirements, which shall include the following:
 1. Organizational chart for the contract to be bid (*Annex "B" Form 3*); and

List of contractor's key personnel (e.g., Project Manager, Project Engineers, Materials Engineers, and Foremen), to be assigned to the contract to be bid, with their complete qualification and experience data (*Annex "B" Form 4, 5a, 5b & 5c*); and

3. List of contractor's major equipment units, which are owned, leased, and/or under purchase agreements, supported by proof of ownership or certification of availability of equipment from the equipment lessor/vendor for the duration of the project, as the case may be (*Annex "B" Form 6*); and

j. Original duly signed Omnibus Sworn Statement (OSS) (*Annex "B" Form 7*); and if applicable, Original Notarized Secretary's Certificate in case of a corporation, partnership, or cooperative; or Original Special Power of Attorney of all members of the joint venture giving full power and authority to its officer to sign the OSS and do acts to represent the Bidder; and

This shall include all of the following documents as attachment to the Omnibus Sworn Statement:

1. Certification, under oath, attesting that they have no pending case(s) against the Government, in addition to the eligibility requirements as prescribe under the 2016 Revise Implementing Rules and Regulation (R-IRR) of RA No. 9184; and
2. Legal Clearance to be issued by the CAAP Enforcement and Legal Service with respect to the non-pending cases of the prospective bidders against this Authority; and
3. Bid Bulletins (if applicable); and

k. **Certificate of Site Inspection** (*Annex "B" Form 1*) duly signed by **Mr. Glenn D. Tripulca, Acting Area Manager of Area III or his** duly authorized representative; and

This shall include all of the following documents as attachment to the Certificate of Site Inspection:

- a) Copy of company ID of the person who conducted the site inspection; and
- b) Copy of the airport/facility visitor's logbook; and
- c) Picture of the proposed site including the personnel who conducted the site inspection together with the Airport Manager/Officer in Charge or his duly authorized representative: and

	<p><u>Financial Documents</u></p> <p>1. The prospective bidder's audited financial statements, showing, among others, the prospective bidder's total and current assets and liabilities, stamped and received by the BIR or its duly accredited and authorized institutions, for the preceding calendar year which should not be earlier than two (2) years from the date of bid submission; and</p> <p>m. The prospective bidder's computation of Net Financial Contracting Capacity(NFCC).</p> <p>Class "B" Documents</p> <p>n. If applicable, duly signed joint venture agreement (JVA) in accordance with RA No. 4566 and its IRR in case the joint venture is already in existence; or duly notarized statements from all the potential joint venture partners stating that they will enter into and abide by the provisions of the JVA in the instance that the bid is successful.</p> <p>Bids not complying with the above instruction shall be disqualified.</p>																																	
10.3	<p>Valid PCAB License or Special PCAB License in case of Joint Ventures, and Registration (<i>Small B License Category C & D for vertical works - Building and Industrial Plant</i>) for the type and cost of the contract to be bid.</p> <p>Bids not complying with the above instruction shall be disqualified.</p>																																	
10.4	<p>The key personnel must meet the required minimum years of experience set below:</p> <table border="1"> <thead> <tr> <th><u>Key Personnel</u></th> <th><u>General Experience</u></th> <th><u>Relevant Experience</u></th> </tr> </thead> <tbody> <tr> <td>(1) Project (Civil) Engineer</td> <td>Five (5) years in</td> <td rowspan="3">} Five (5) years in vertical structures</td> </tr> <tr> <td>(1) Plumber</td> <td>General</td> </tr> <tr> <td>(1) Electrician</td> <td>Engineering</td> </tr> </tbody> </table>	<u>Key Personnel</u>	<u>General Experience</u>	<u>Relevant Experience</u>	(1) Project (Civil) Engineer	Five (5) years in	} Five (5) years in vertical structures	(1) Plumber	General	(1) Electrician	Engineering																							
<u>Key Personnel</u>	<u>General Experience</u>	<u>Relevant Experience</u>																																
(1) Project (Civil) Engineer	Five (5) years in	} Five (5) years in vertical structures																																
(1) Plumber	General																																	
(1) Electrician	Engineering																																	
10.5	<p>The minimum major equipment requirements are the following:</p> <table border="1"> <thead> <tr> <th><u>Equipment</u></th> <th><u>Capacity</u></th> <th><u>Number of Units</u></th> </tr> </thead> <tbody> <tr> <td>Air Compressor & Jack Hammer</td> <td></td> <td></td> </tr> <tr> <td>Concrete Saw</td> <td></td> <td></td> </tr> <tr> <td>Electric Drill</td> <td></td> <td></td> </tr> <tr> <td>One-bagger Concrete Mixer</td> <td></td> <td></td> </tr> <tr> <td>Concrete Vibrator</td> <td></td> <td></td> </tr> <tr> <td>Welding Machine</td> <td></td> <td></td> </tr> <tr> <td>Portable Generator Set</td> <td></td> <td></td> </tr> <tr> <td>Oxy-Acetylene Cutting Torch</td> <td></td> <td></td> </tr> <tr> <td>Angle Grinder</td> <td></td> <td></td> </tr> <tr> <td>Electric Hand Drill</td> <td></td> <td></td> </tr> </tbody> </table>	<u>Equipment</u>	<u>Capacity</u>	<u>Number of Units</u>	Air Compressor & Jack Hammer			Concrete Saw			Electric Drill			One-bagger Concrete Mixer			Concrete Vibrator			Welding Machine			Portable Generator Set			Oxy-Acetylene Cutting Torch			Angle Grinder			Electric Hand Drill		
<u>Equipment</u>	<u>Capacity</u>	<u>Number of Units</u>																																
Air Compressor & Jack Hammer																																		
Concrete Saw																																		
Electric Drill																																		
One-bagger Concrete Mixer																																		
Concrete Vibrator																																		
Welding Machine																																		
Portable Generator Set																																		
Oxy-Acetylene Cutting Torch																																		
Angle Grinder																																		
Electric Hand Drill																																		
11.1	<p>The discounts stated in the Financial Bid Form shall be computer written with the same font style and size as of the whole text of the said Form.</p> <p>Discounts that are either handwritten, type written or computer written in other font style and size shall not be considered.</p> <p>The second bid envelope shall contain the financial documents for the Bid as specified in Section X. Checklist of Technical and Financial</p>																																	

	<p>Documents.</p> <p>This shall include the complete accomplishment of all of the following documents as stated and required under Section VIII of this PBD and shall form part of the bidder's financial documents:</p> <ul style="list-style-type: none"> a) Original of duly signed and accomplished Financial Bid Form; and b) Bill of Quantities (<i>Annex "C" Form 1</i>); and c) Summary of Bid Proposal (<i>Annex "C" Form 2</i>); and d) Bill of Materials & Cost Estimates (<i>Annex "C" Form 3</i>); and e) Summary Sheet indicating the Unit Prices of Construction Materials, Labor Rates, and Equipment Rentals used in coming up with the Bid (<i>Annex "C" Form 4, 5 & 6</i>); and f) Cash Flow by Quarter and Payment Schedule (<i>Annex "C" Form 7</i>) <p>Bids not complying with the above instruction shall be disqualified.</p>
11.2	Bid exceeding the ABC of the project shall be disqualified.
12	No further instructions.
15.1	<p>The bid security shall be in the form of a Bid Securing Declaration or any of the following forms and amounts:</p> <ul style="list-style-type: none"> a. The amount of not less than Php 41,250.00 (2% of ABC), if bid security is in cash, cashier's/manager's check, bank draft/guarantee or irrevocable letter of credit; b. The amount of not less than Php 103,125.00 (5% of ABC) if bid security is in Surety Bond.
16	<p>1. Each and every page thereof shall be initialed/signed by the duly authorized representative/s of the Bidder.</p> <p>Submitted Eligibility, Technical and Financial documents shall be properly marked with index tabs (ear tab) and must be sequentially paginated in accurate order in the form i.e. page 3 of 100. Page number of last page of the document (per envelope basis).</p> <p>Pagination should be sequential based on the entire span of the whole documents inside the envelope.</p> <p>Bids not complying with the above instructions shall be automatically disqualified.</p> <p>2. Each Bidder shall submit one (1) original and two (2) copies of the first and second components of its bid.</p>
19.2	Partial bid is not allowed. The infrastructure project is packaged in a single lot and the lot shall not be divided into sub-lots for the purpose of bidding, evaluation, and contract award.

20	<p>The Bidder with the Lowest Calculated Bid (LCB) that complies with and is responsive to all the requirements and conditions shall submit its</p> <ul style="list-style-type: none"> a) Latest income and business tax returns filed through the Electronic Filing and Payment System(EFPS); b) Business licenses and permits required by law (Registration Certificate, Mayor's Permit, Tax Clearance & PCAB License); c) Latest Audited Financial Statements; and d) Key personnel licenses <p>Failure to submit any of the post-qualification requirements on time, or a finding against the veracity thereof, shall disqualify the bidder for award. Provided, that in the event that a finding against the veracity of any of the documents submitted is made, it shall cause the forfeiture of the Bid Security in accordance with Section 69 of the IRR of RA 9184.</p>
21	<p>The following relevant project documents are required to be submitted by the successful bidder who submitted the LCRB as part of the Contract Agreement during its signing:</p> <ul style="list-style-type: none"> a) Construction schedule b) Bar Chart & S-curve c) PERT/CPM Network Diagram d) Manpower schedule e) Construction methods f) Equipment utilization schedule <p>Construction safety & health programs approved by the Department of Labor & Employment</p>

Section IV. General Conditions of Contract

Notes on the General Conditions of Contract

The General Conditions of Contract (GCC) in this Section, read in conjunction with the Special Conditions of Contract in Section V and other documents listed therein, should be a complete document expressing all the rights and obligations of the parties.

Matters governing performance of the Contractor, payments under the contract, or matters affecting the risks, rights, and obligations of the parties under the contract are included in the GCC and Special Conditions of Contract.

Any complementary information, which may be needed, shall be introduced only through the Special Conditions of Contract.

1. Scope of Contract

This Contract shall include all such items, although not specifically mentioned, that can be reasonably inferred as being required for its completion as if such items were expressly mentioned herein. All the provisions of RA No. 9184 and its 2016 revised IRR, including the Generic Procurement Manual, and associated issuances, constitute the primary source for the terms and conditions of the Contract, and thus, applicable in contract implementation. Herein clauses shall serve as the secondary source for the terms and conditions of the Contract.

This is without prejudice to Sections 74.1 and 74.2 of the 2016 revised IRR of RA No. 9184 allowing the GPPB to amend the IRR, which shall be applied to all procurement activities, the advertisement, posting, or invitation of which were issued after the effectivity of the said amendment.

2. Sectional Completion of Works

If sectional completion is specified in the **Special Conditions of Contract (SCC)**, references in the Conditions of Contract to the Works, the Completion Date, and the Intended Completion Date shall apply to any Section of the Works (other than references to the Completion Date and Intended Completion Date for the whole of the Works).

3. Possession of Site

3.1 The Procuring Entity shall give possession of all or parts of the Site to the Contractor based on the schedule of delivery indicated in the **SCC**, which corresponds to the execution of the Works. If the Contractor suffers delay or incurs cost from failure on the part of the Procuring Entity to give possession in accordance with the terms of this clause, the Procuring Entity's Representative shall give the Contractor a Contract Time Extension and certify such sum as fair to cover the cost incurred, which sum shall be paid by Procuring Entity.

3.2 If possession of a portion is not given by the above date, the Procuring Entity will be deemed to have delayed the start of the relevant activities. The resulting adjustments in contract time to address such delay may be addressed through contract extension provided under Annex "E" of the 2016 revised IRR of RA No. 9184.

4. The Contractor's Obligations

The Contractor shall employ the key personnel named in the Schedule of Key Personnel indicating their designation, in accordance with **ITB** Clause 10.3 and specified in the **BDS**, to carry out the supervision of the Works.

The Procuring Entity will approve any proposed replacement of key personnel only if their relevant qualifications and abilities are equal to or better than those of the personnel listed in the Schedule.

5. Performance Security

- 5.1. Within ten (10) calendar days from receipt of the Notice of Award from the Procuring Entity but in no case later than the signing of the contract by both parties, the successful Bidder shall furnish the performance security in any of the forms prescribed in Section 39 of the 2016 revised IRR.
- 5.2. The Contractor, by entering into the Contract with the Procuring Entity, acknowledges the right of the Procuring Entity to institute action pursuant to RA No. 3688 against any subcontractor be they an individual, firm, partnership, corporation, or association supplying the Contractor with labor, materials and/or equipment for the performance of this Contract.

6. Site Investigation Reports

The Contractor, in preparing the Bid, shall rely on any Site Investigation Reports referred to in the **SCC** supplemented by any information obtained by the Contractor.

7. Warranty

- 7.1. In case the Contractor fails to undertake the repair works under Section 62.2.2 of the 2016 revised IRR, the Procuring Entity shall forfeit its performance security, subject its property(ies) to attachment or garnishment proceedings, and perpetually disqualify it from participating in any public bidding. All payables of the GOP in his favor shall be offset to recover the costs.
- 7.2. The warranty against Structural Defects/Failures, except that occasioned-on force majeure, shall cover the period from the date of issuance of the Certificate of Final Acceptance by the Procuring Entity. Specific duration of the warranty is found in the **SCC**.

8. Liability of the Contractor

Subject to additional provisions, if any, set forth in the **SCC**, the Contractor's liability under this Contract shall be as provided by the laws of the Republic of the Philippines.

If the Contractor is a joint venture, all partners to the joint venture shall be jointly and severally liable to the Procuring Entity.

9. Termination for Other Causes

Contract termination shall be initiated in case it is determined *prima facie* by the Procuring Entity that the Contractor has engaged, before, or during the implementation of the contract, in unlawful deeds and behaviors relative to contract acquisition and implementation, such as, but not limited to corrupt, fraudulent, collusive, coercive, and obstructive practices as stated in **ITB** Clause 4.

10. Dayworks

Subject to the guidelines on Variation Order in Annex “E” of the 2016 revised IRR of RA No. 9184, and if applicable as indicated in the **SCC**, the Dayworks rates in the Contractor’s Bid shall be used for small additional amounts of work only when the Procuring Entity’s Representative has given written instructions in advance for additional work to be paid for in that way.

11. Program of Work

11.1. The Contractor shall submit to the Procuring Entity’s Representative for approval the said Program of Work showing the general methods, arrangements, order, and timing for all the activities in the Works. The submissions of the Program of Work are indicated in the **SCC**.

11.2. The Contractor shall submit to the Procuring Entity’s Representative for approval an updated Program of Work at intervals no longer than the period stated in the **SCC**. If the Contractor does not submit an updated Program of Work within this period, the Procuring Entity’s Representative may withhold the amount stated in the **SCC** from the next payment certificate and continue to withhold this amount until the next payment after the date on which the overdue Program of Work has been submitted.

12. Instructions, Inspections and Audits

The Contractor shall permit the GOP or the Procuring Entity to inspect the Contractor’s accounts and records relating to the performance of the Contractor and to have them audited by auditors of the GOP or the Procuring Entity, as may be required.

13. Advance Payment

The Procuring Entity shall, upon a written request of the Contractor which shall be submitted as a Contract document, make an advance payment to the Contractor in an amount not exceeding fifteen percent (15%) of the total contract price, to be made in lump sum, or at the most two installments according to a schedule specified in the **SCC**, subject to the requirements in Annex “E” of the 2016 revised IRR of RA No. 9184.

14. Progress Payments

The Contractor may submit a request for payment for Work accomplished. Such requests for payment shall be verified and certified by the Procuring Entity’s Representative/Project Engineer. Except as otherwise stipulated in the **SCC**, materials and equipment delivered on the site but not completely put in place shall not be included for payment.

15. Operating and Maintenance Manuals

- 15.1. If required, the Contractor will provide “as built” Drawings and/or operating and maintenance manuals as specified in the **SCC**.
- 15.2. If the Contractor does not provide the Drawings and/or manuals by the dates stated above, or they do not receive the Procuring Entity’s Representative’s approval, the Procuring Entity’s Representative may withhold the amount stated in the **SCC** from payments due to the Contractor.

Section V. Special Conditions of Contract

Notes on the Special Conditions of Contract

Similar to the BDS, the clauses in this Section are intended to assist the Procuring Entity in providing contract-specific information in relation to corresponding clauses in the GCC found in Section IV.

The Special Conditions of Contract (SCC) complement the GCC, specifying contractual requirements linked to the special circumstances of the Procuring Entity, the Procuring Entity's country, the sector, and the Works procured. In preparing this Section, the following aspects should be checked:

- a. Information that complements provisions of the GCC must be incorporated.
- b. Amendments and/or supplements to provisions of the GCC as necessitated by the circumstances of the specific purchase, must also be incorporated.

However, no special condition which defeats or negates the general intent and purpose of the provisions of the GCC should be incorporated herein.

Special Conditions of Contract

GCC Clause	
2	Not applicable.
3.1	The CIVIL AVIATION AUTHORITY OF THE PHILIPPINES shall give possession of all parts of the Site to the Contractor upon receipt of the Notice to Proceed.
6	None
7.2	In case of permanent structures, such as buildings of types 4 and 5 as classified under the National Building Code of the Philippines and other structures made of steel, iron, or concrete which comply with relevant structural codes (e.g., DPWH Standard Specifications), such as, but not limited to, steel/concrete bridges, flyovers, aircraft movement areas, ports, dams, tunnels, filtration and treatment plants, sewerage systems, power plants, transmission and communication towers, railway system, and other similar permanent structures: Fifteen (15) years.
10	No dayworks are applicable to the contract.
11.1	Not applicable
11.2	Not applicable
13	The amount of the advance payment shall not exceed 15% of the total contract price. However, as per Department of Transportation (DOTr) Policy, Procuring Entity will not give advance payment to contractors.
14	No further instructions.
15.1	<p>The date by which operating and maintenance manuals are required is upon completion of the project</p> <p>The date by which as built drawings are required is upon completion of the project.</p> <p>PDF/AutoCAD File of the as built plans shall include as attachment to the required hard copy of the same upon completion of the project.</p>
15.2	The amount to be withheld for failing to produce “as built” drawings and/or operating and maintenance manuals by the date required is two percent (2.00%) of the Contract price.

Section VI. Specifications

Notes on Specifications

A set of precise and clear specifications is a prerequisite for Bidders to respond realistically and competitively to the requirements of the Procuring Entity without qualifying or conditioning their Bids. In the context of international competitive bidding, the specifications must be drafted to permit the widest possible competition and, at the same time, present a clear statement of the required standards of workmanship, materials, and performance of the goods and services to be procured. Only if this is done will the objectives of economy, efficiency, and fairness in procurement be realized, responsiveness of Bids be ensured, and the subsequent task of bid evaluation facilitated. The specifications should require that all goods and materials to be incorporated in the Works be new, unused, of the most recent or current models, and incorporate all recent improvements in design and materials unless provided otherwise in the Contract.

Samples of specifications from previous similar projects are useful in this respect. The use of metric units is mandatory. Most specifications are normally written specially by the Procuring Entity or its representative to suit the Works at hand. There is no standard set of Specifications for universal application in all sectors in all regions, but there are established principles and practices, which are reflected in these PBDs.

There are considerable advantages in standardizing General Specifications for repetitive Works in recognized public sectors, such as highways, ports, railways, urban housing, irrigation, and water supply, in the same country or region where similar conditions prevail. The General Specifications should cover all classes of workmanship, materials, and equipment commonly involved in construction, although not necessarily to be used in a particular Works Contract. Deletions or addenda should then adapt the General Specifications to the particular Works.

Care must be taken in drafting specifications to ensure that they are not restrictive. In the specification of standards for goods, materials, and workmanship, recognized international standards should be used as much as possible. Where other particular standards are used, whether national standards or other standards, the specifications should state that goods, materials, and workmanship that meet other authoritative standards, and which ensure substantially equal or higher quality than the standards mentioned, will also be acceptable. The following clause may be inserted in the SCC.

Sample Clause: Equivalency of Standards and Codes

Wherever reference is made in the Contract to specific standards and codes to be met by the goods and materials to be furnished, and work performed or tested, the provisions of the latest current edition or revision of the relevant standards and codes in effect shall apply, unless otherwise expressly stated in the Contract. Where such standards and codes are national, or relate to a particular country or region, other authoritative standards that

ensure a substantially equal or higher quality than the standards and codes specified will be accepted subject to the Procuring Entity's Representative's prior review and written consent. Differences between the standards specified and the proposed alternative standards shall be fully described in writing by the Contractor and submitted to the Procuring Entity's Representative at least twenty-eight (28) days prior to the date when the Contractor desires the Procuring Entity's Representative's consent. In the event the Procuring Entity's Representative determines that such proposed deviations do not ensure substantially equal or higher quality, the Contractor shall comply with the standards specified in the documents.

These notes are intended only as information for the Procuring Entity or the person drafting the Bidding Documents. They should not be included in the final Bidding Documents.

Name of Project : **Construction of CSIS Office at Plaridel Airport**
Location : Lumangbayan Plaridel Bulacan
Duration : Ninety (90) Calendar Days (inclusive of Nine
(9) rainy/unworkable days)
Source of Funds : CAAP Corporate Budget CY 2022

SCOPE OF WORK

I. GENERAL

The works to be accomplished by the successful bidder shall consist of furnishing, supervision, labor, materials, supplies, tools and equipment to complete the **Construction of CSIS Office at Plaridel Airport.**

II. LOCATION OF PROJECT

The Contract to be bid is located at **Plaridel Airport, Plaridel, Bulacan.**

III. SCOPE OF WORK

The details of work are at best enumerated below, but be noted that the Contract includes all works and services although not specifically mentioned herein, but are needed to fully complete the Project.

The Project covers the supply of labor, materials, mobilization/demobilization, tools/equipment, necessary for **Construction of CSIS Office at Plaridel Airport** with the following scope of works which shall be done in accordance with the approved plans, specifications and provision of contract to wit: (Work shall include but is not limited to the following);

3.1. Mobilization / Demobilization

This work includes mobilization and demobilization of the contractor's forces and equipment necessary for performing the work required under the contract.

- a. Mobilization shall include all activities and associated costs for transportation of contractor's personnel, equipment, and operating supplies to the site; establishment of offices, buildings and other necessary general facilities for the contractor's operations at the site.
- b. Demobilization shall include the disassembly, hauling/removal of debris/rubbish, and site clean-up of offices, buildings and other facilities assembled on the site.

3.2. Civil Works

a. Site Works

The work includes all materials and labor for site works including excavation, demolition of existing structure, demolition of existing pavement prior to the construction of wall and column footings and provision of compacted gravel bedding and soil poisoning as indicated on plans and specifications. The work also includes the disposal of the removed materials.

b. Concrete Works

The work includes labor, materials and equipment/tools for the construction of all concrete works including formworks and installation of reinforced steel bar for column footings, columns, beams, slab on grade and wall footings as specified on the approved plans. (Materials to be used and workmanship must be approved by the Project-In-Charge assigned by CAAP)

- Volume of concrete : 16.10 m³
- Total weight of reinforcing bars : 1,082.89 kg.
- Total area of formworks : 89.46 m²

c. Masonry Works

The work includes labor, materials and equipment/tools for the laying of 150mm concrete hollow blocks (CHB) including mortar, plastering and installation of reinforcing steel bars as indicated on plans. (Materials to be used and workmanship must be approved by the Project-In-Charge assigned by CAAP)

- Total area of masonry works : 92.25 m²

d. Steel Works

The work includes labor, materials and equipment/tools needed to complete the steel works including fabrication, installation and painting of angular bars, MS plates and steel trusses as indicated on the approved plans. The contractor must secure the scaffoldings, formworks and material testing prior to the installation of steel structure members. (Materials to be used and workmanship must be approved by the Project-In-Charge assigned by CAAP)

- Total weight of steel works: 356.96 kg.

e. Roofing Works

The work includes labor, materials and equipment/tools needed to complete the roofing works including fabrication and installation of pre-painted long span rib-type roofing sheet GA#24, pre-painted G.I. gutter and flushing GA#24, pre-painted ridge cap GA#26, and polyethylene foam with one (1) side aluminum as indicated on the approved plans. (Materials to be used and workmanship must be approved by the Project-In-Charge assigned by CAAP)

f. Catch Basin

The work includes labor, materials and tools needed to complete the construction of five (5) units of catch basin as indicated on the approved plans. (Materials to be used and workmanship must be approved by the Project-In-Charge assigned by CAAP)

- Volume of concrete : 0.30 m³
- Total weight of reinforcing bars: 59.19 kg.
- Total area of masonry works : 1.80 m²

3.3. Architectural Works

a. Tile Works

The work includes labor, materials and tools to complete the tile works: 60cm x 60cm homogenous porcelain polished floor tiles for flooring, 60cm x 60cm homogenous porcelain polished tiles for kitchen counter, 30cm x 30cm homogenous porcelain wall tiles and 30cm x 30cm non-skid homogenous porcelain ceramic floor tiles for T&B, as per indicated on program of work. (Materials used and workmanship must be approved by the Project-In-Charge assigned by CAAP).

- Total area of tile works : 50.55 m²

b. Carpentry Works

The work includes labor, materials and tools to complete the installation of ceiling framing and 4.5mm thick x 4' x 8' fiber cement boards for ceiling boards including carrying channel and double furring for ceiling frame, wood ventilation. Installation of 6mm thick x 4' x 8' fiber cement boards for dry wall and metal studs and tracks. (Materials used and workmanship must be approved by the Project-In-Charge assigned by CAAP).

- Total area of carpentry works: 119.78 m²

c. Painting Works

The work includes labor, materials and tools to complete the painting works of exterior wall, interior wall, fascia board and ceiling using acrylic paint; steel and wood using enamel paint, as per indicated on program of work. (Materials used and workmanship must be approved by the Project-In-Charge assigned by CAAP).

- Total area for acrylic paint : 290.39 m²
- Total area for enamel paint : 14.60 m²

d. Doors and Windows

The work includes labor, materials and tools to complete installation of doors and windows, complete with hardware and accessories, including jamb and header, as per indicated on program of work. (Materials used and workmanship must be approved by the Project-In-Charge assigned by CAAP).

- No. of doors : 4 sets
- No. of windows : 5 sets

3.4. Electrical Works

The work includes labor materials, equipment and performance of all operations to complete the installation of the following: lighting and power conduits and fittings, wires and cables, electrical wiring devices, lighting fixtures, boxes, ACU power supply, telephone and data, panel board/circuit breaker, feeder/sub-feeder conductor, conduits and fittings and termination accessories as indicated on plans. (Materials used and workmanship must be approved by the Project-In-Charge assigned by CAAP).

3.5. Mechanical Works

The work includes labor materials, equipment and tools to complete the installation of air conditioning unit and piping system, ventilation equipment and accessories, hangers and supports and fire extinguisher as indicated on the plans. (Materials used and workmanship must be approved by the Project-In-Charge assigned by CAAP).

- 1.0HP, Dual Inverter Compressor, 70% Energy Saving, Fast Cooling, Low Noise, Auto Clean, Active Energy Control Split Type ACU w/ complete standard accessories, Power Supply 230V 1Ø, 60Hz, Refrigerant Type: R32
- 2.0HP, Dual Inverter Compressor, 70% Energy Saving, Fast Cooling, Low Noise, Auto Clean, Active Energy Control Split Type ACU w/ complete standard accessories, Power Supply 230V 1Ø, 60Hz, Refrigerant Type: R32

3.6. Plumbing and Sanitary Works

The work includes labor materials, equipment and performance of all operations to complete the installation of water line pipes, sewer line, storm drainage line, and installation of plumbing fixtures with accessories and fittings as indicated on plans. (Materials used and workmanship must be approved by the Project-In-Charge assigned by CAAP).

3.7. Furniture

The work includes supply of all furniture as indicated on program of work. (All furniture must be approved by the Project-In-Charge assigned by CAAP).

All scope of work to this item must be according to plan and specifications and approved by the Engineer-In-Charge. Quality and types of materials must conform and to be approved by the Project Engineer assigned by CAAP.

The contractor shall be responsible in providing personal protective equipment (PPE) for staffs and workers, and Safety Inspectors or Safety Engineers on site while construction is ongoing. Regular safety reports should be reported.

The contractor shall be responsible for all laboratory, material testing, environmental compliance certificate (ECC), building and safety permits and survey instruments necessary in the project implementation. All expenses shall be incorporated in the contractor's overhead cost and shall not be considered as pay item.

Section VII. Drawings

[Insert here a list of Drawings. The actual Drawings, including site plans, should be attached to this section, or annexed in a separate folder.]

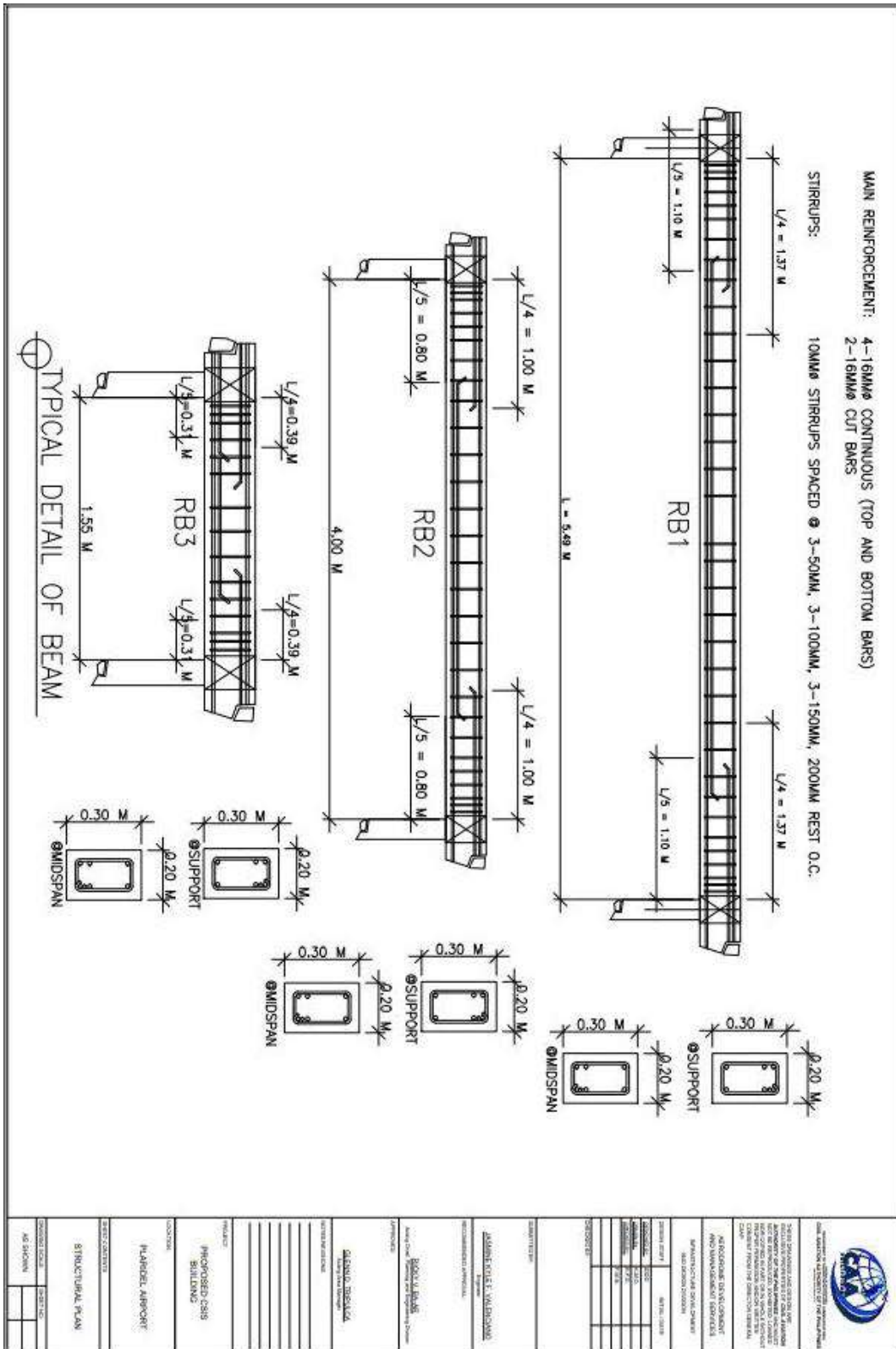

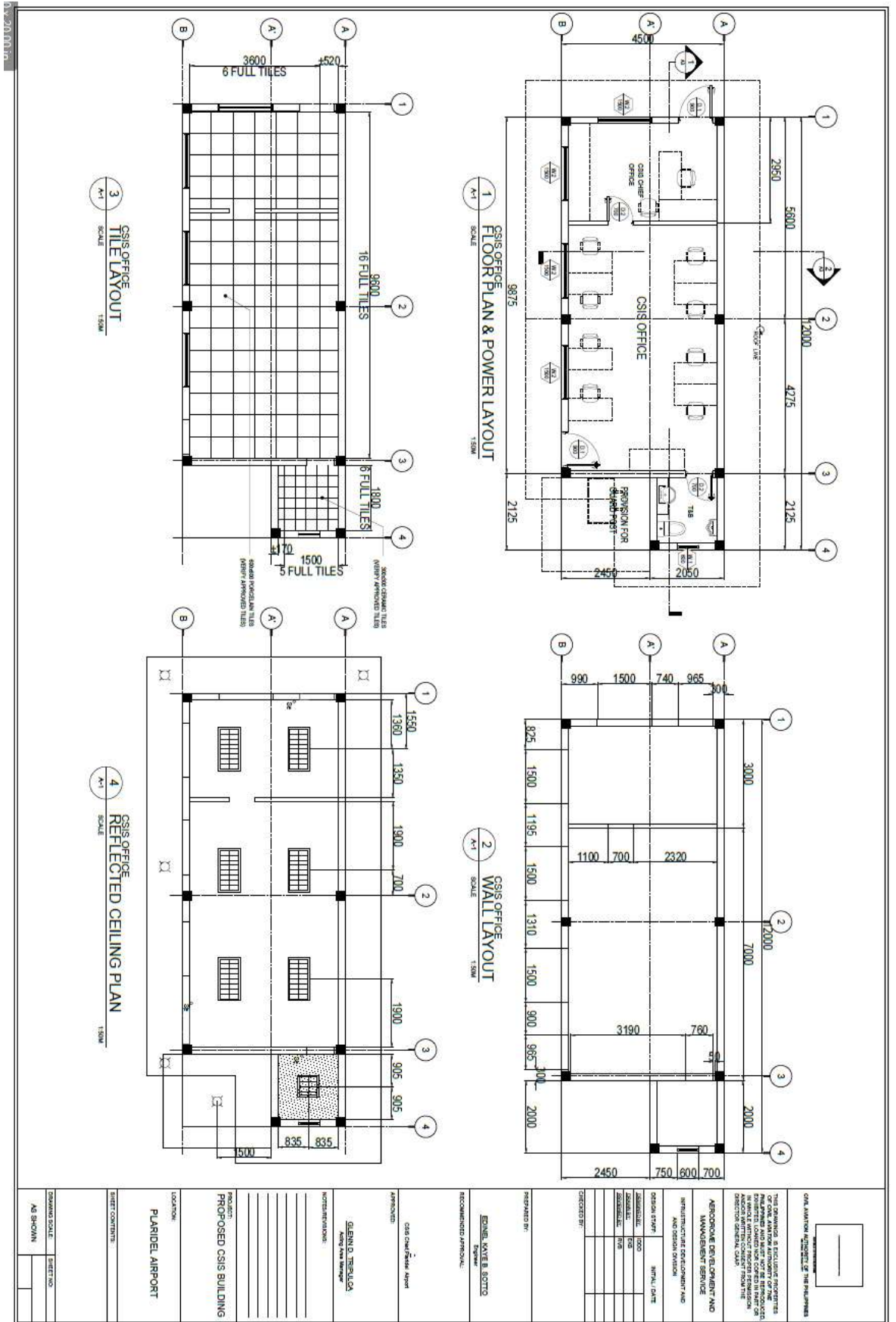

1 CSIS OFFICE FLOOR PLAN & POWER LAYOUT
SCALE: 1/50M

2 CSIS OFFICE WALL LAYOUT
SCALE: 1/50M

3 CSIS OFFICE TILE LAYOUT
SCALE: 1/50M

4 CSIS OFFICE REFLECTED CEILING PLAN
SCALE: 1/50M

<p>ONE APPROVED COPY TO BE MAINTAINED</p>	
<p>THIS DRAWING IS EXCLUSIVE PROPERTY OF PLANSOURCE AND SHALL NOT BE REPRODUCED OR TRANSMITTED IN ANY FORM OR BY ANY MEANS, ELECTRONIC OR MECHANICAL, INCLUDING PHOTOCOPYING, RECORDING, OR BY ANY INFORMATION STORAGE AND RETRIEVAL SYSTEM WITHOUT WRITTEN CONSENT FROM THE PROJECT MANAGER.</p>	
<p>AEROSPACE EQUIPMENT AND MANAGEMENT SERVICE</p>	
<p>INFRASTRUCTURE DEVELOPMENT AND MAINTENANCE SERVICES</p>	
DESIGN STAFF	INITIAL DATE
DESIGNER	2002
ASSISTANT DESIGNER	
APPROVED BY:	
CHECKED BY:	
PREPARED BY:	
<p>EDMUND KUYER, SOTTO Designer</p>	
<p>RECOMMENDED APPROVAL:</p>	
<p>APPROVED:</p>	
<p>GENINA TRISULCA Aerosp. Equip. Mgmt. Serv.</p>	
<p>NOTICE/REFERENCE:</p>	
<p>PROJECT:</p>	
<p>PROPOSED CSIS BUILDING</p>	
<p>LOCATION:</p>	
<p>PLAISIR AIRPORT</p>	
<p>SHEET CONTENTS:</p>	
<p>DRAWING SCALE:</p>	<p>SHEET NO:</p>
<p>AS SHOWN</p>	

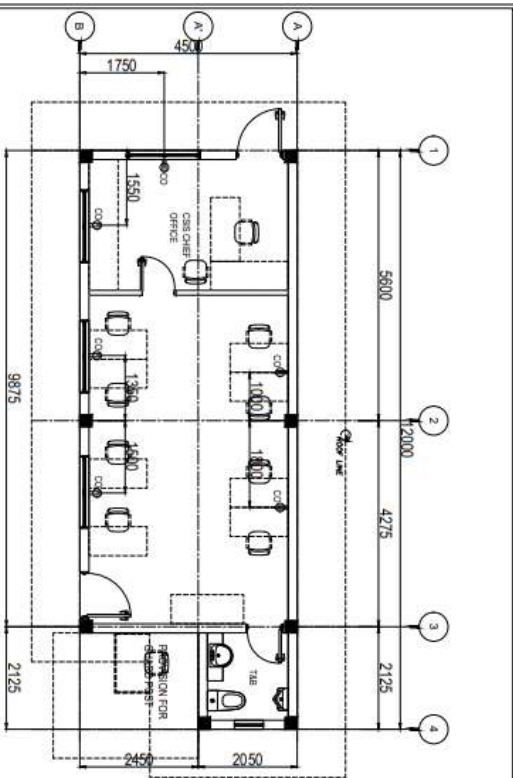

1 CSIS OFFICE POWER LAYOUT
SCALE: 1/32"
AS2

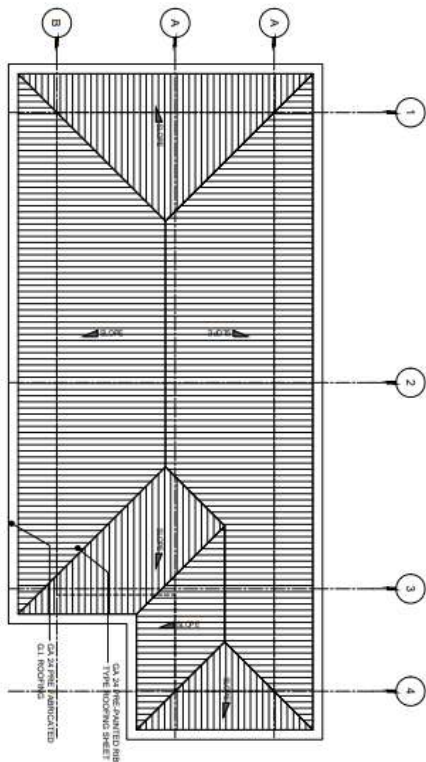

2 CSIS OFFICE FLOOR PLAN & POWER LAYOUT
SCALE: 1/32"
AS2

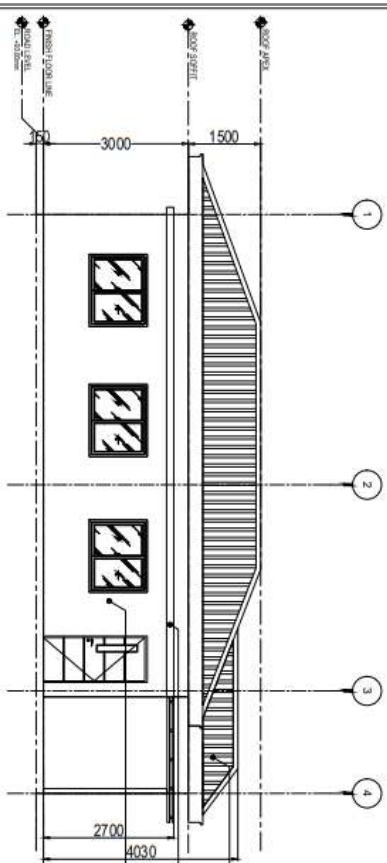

3 CSIS OFFICE FRONT ELEVATION
SCALE: 1/32"
AS2

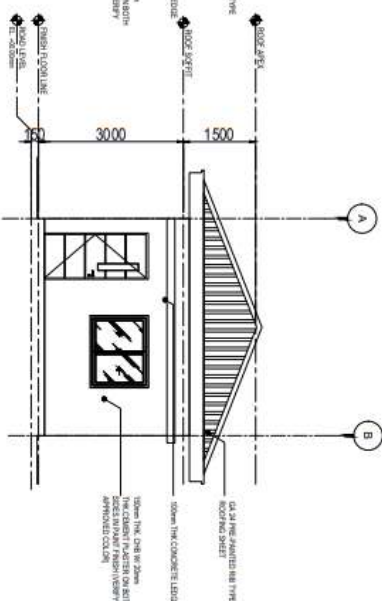

4 CSIS OFFICE LEFT SIDE ELEVATION
SCALE: 1/32"
AS2

CIVIL AVIATION AUTHORITY OF THE PHILIPPINES DEPARTMENT OF TRANSPORTATION PASAYEN OFFICE PASAYEN AVIATION CENTER PASAYEN CITY, METRO MANILA DIRECTOR GENERAL, CAP DIRECTOR GENERAL, CAP	
PREPARED BY: EMIL KAYE B. SOTIO Engineer	
RECOMMENDED APPROVAL: CSIS Chief/Project Agent APPROVED: GLEN D. TERBLACK Acting Head Manager	
NOTES/REVISIONS: _____ _____ _____	
PROJECT: PROPOSED CSIS BUILDING	
LOCATION: PLARDEL AIRPORT	
SHEET CONTENTS: DRAWING SCALE AS SHOWN SHEET NO. _____	

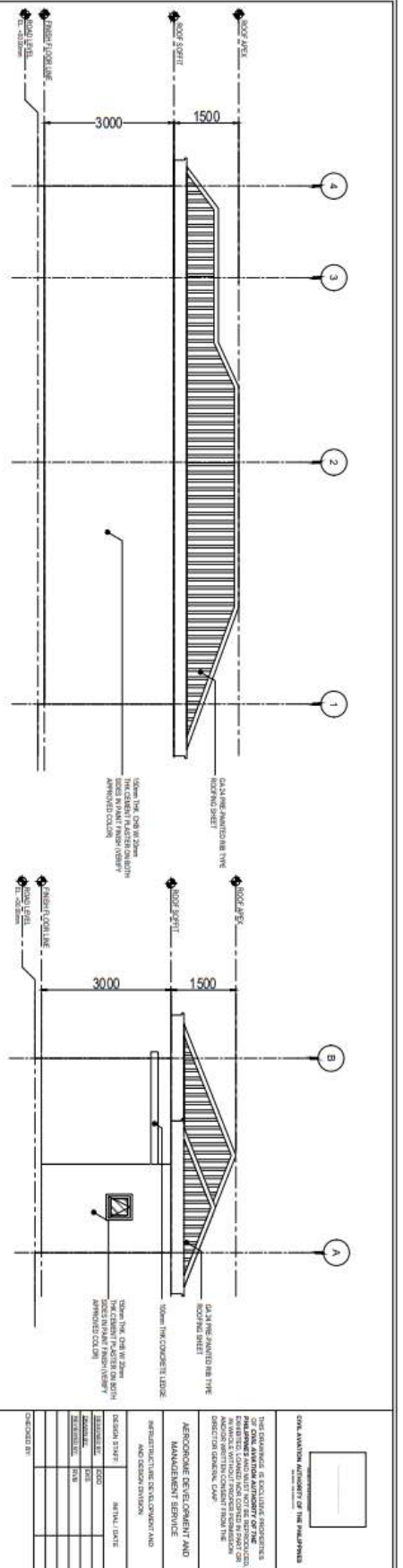

1 CSIS OFFICE REAR ELEVATION
SCALE: A:3

2 CSIS OFFICE RIGHT SIDE ELEVATION
SCALE: A:3

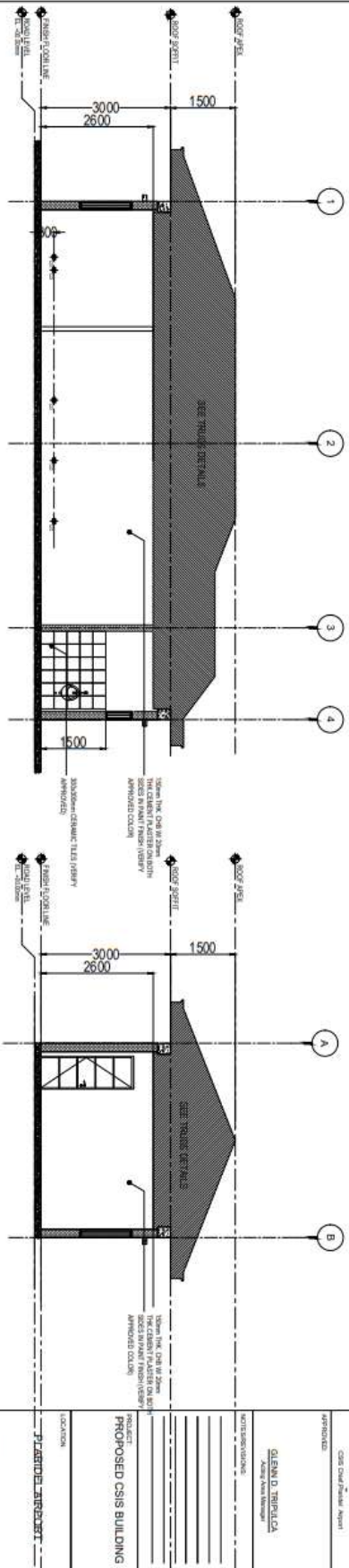

3 CSIS OFFICE LONGITUDINAL SECTION
SCALE: A:3

4 CSIS OFFICE CROSS SECTION
SCALE: A:3

<p>THESE DRAWINGS ARE THE PROPERTY OF THE ARCHITECT AND ARE NOT TO BE REPRODUCED OR COPIED IN ANY MANNER WITHOUT THE WRITTEN PERMISSION OF THE ARCHITECT.</p>	
<p>CLIENT: AIR CANADA</p>	
<p>PROJECT: PROPOSED CSIS BUILDING</p>	
<p>LOCATION: PLAZA DE L'ARCHITECTE</p>	
<p>DATE: 2011</p>	
<p>SCALE: AS SHOWN</p>	
<p>APPROVED BY: GLENN D. TRIPALDA, Architect</p>	
<p>ENGINEER: ENRIQUE VALE R. SOTO, Engineer</p>	
<p>RECOMMENDED APPROVAL:</p>	
<p>DESIGNER: CSIS (Civil/Structural Dept)</p>	
<p>CHECKED BY:</p>	
<p>DESIGN STAFF:</p>	
DESIGNER	DATE
APPROVED	DATE
CHECKED	DATE
DESIGNED	DATE

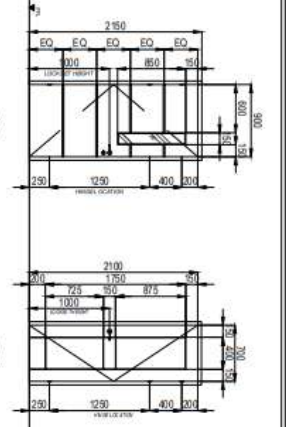

0.2
0.4

NO.	DESCRIPTION	LOCATION	QUANTITY
1	GLASS WINDOW (GLAZING) WITH ALUMINUM FRAME	OFFICE A	1
2	GLASS WINDOW (GLAZING) WITH ALUMINUM FRAME	OFFICE B	1
3	GLASS WINDOW (GLAZING) WITH ALUMINUM FRAME	OFFICE C	1
4	GLASS WINDOW (GLAZING) WITH ALUMINUM FRAME	OFFICE D	1

NO.	DESCRIPTION	LOCATION	QUANTITY
1	GLASS WINDOW (GLAZING) WITH ALUMINUM FRAME	OFFICE A	1
2	GLASS WINDOW (GLAZING) WITH ALUMINUM FRAME	OFFICE B	1
3	GLASS WINDOW (GLAZING) WITH ALUMINUM FRAME	OFFICE C	1
4	GLASS WINDOW (GLAZING) WITH ALUMINUM FRAME	OFFICE D	1

1
A.5
SCALE
DOORS AND WINDOWS SCHEDULE
1:2000

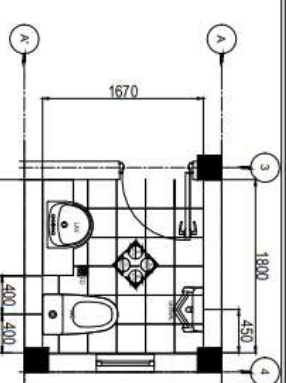

2
A.5
SCALE
OFFICE A FLOOR PLAN
1:2000

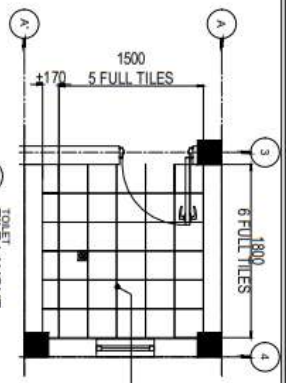

3
A.5
SCALE
OFFICE B FLOOR PLAN
1:2000

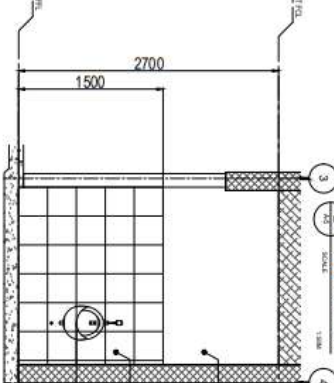

4
A.5
SCALE
OFFICE C FLOOR PLAN
1:2000

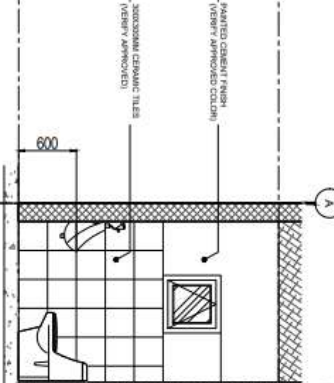

5
A.5
SCALE
OFFICE D FLOOR PLAN
1:2000

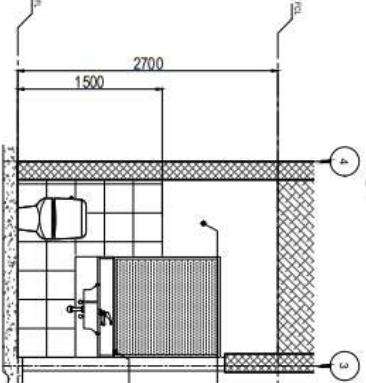

6
A.5
SCALE
TOILET FLOOR PLAN
1:2000

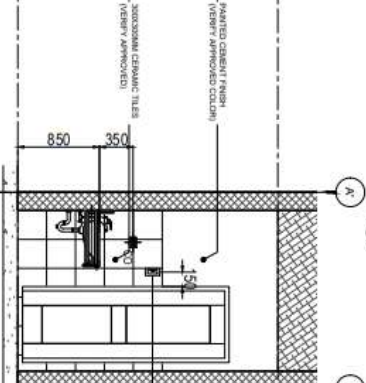

7
A.5
SCALE
TOILET FLOOR PLAN
1:2000

ONE ANCHOR MOUNTING OF THE PANELS

THIS DRAWING IS EXCLUSIVE PROPERTY OF THE ARCHITECT AND SHALL NOT BE REPRODUCED OR TRANSMITTED IN ANY FORM OR BY ANY MEANS, WITHOUT EXPRESS PERMISSION IN WRITING FROM THE ARCHITECT.

ARCHITECTURE DEVELOPMENT AND MANAGEMENT SERVICE

DESIGNED BY: ENRIQUE MATEO B. SOTO

RECOMMENDED APPROVAL:

PROJECT: PROPOSED CSIS BUILDING

LOCATION: PLARDEL AIRPORT

DATE: 15/01/2023

SCALE: AS SHOWN

PROJECT: PROPOSED CSIS BUILDING

LOCATION: PLARDEL AIRPORT

DATE: 15/01/2023

SCALE: AS SHOWN

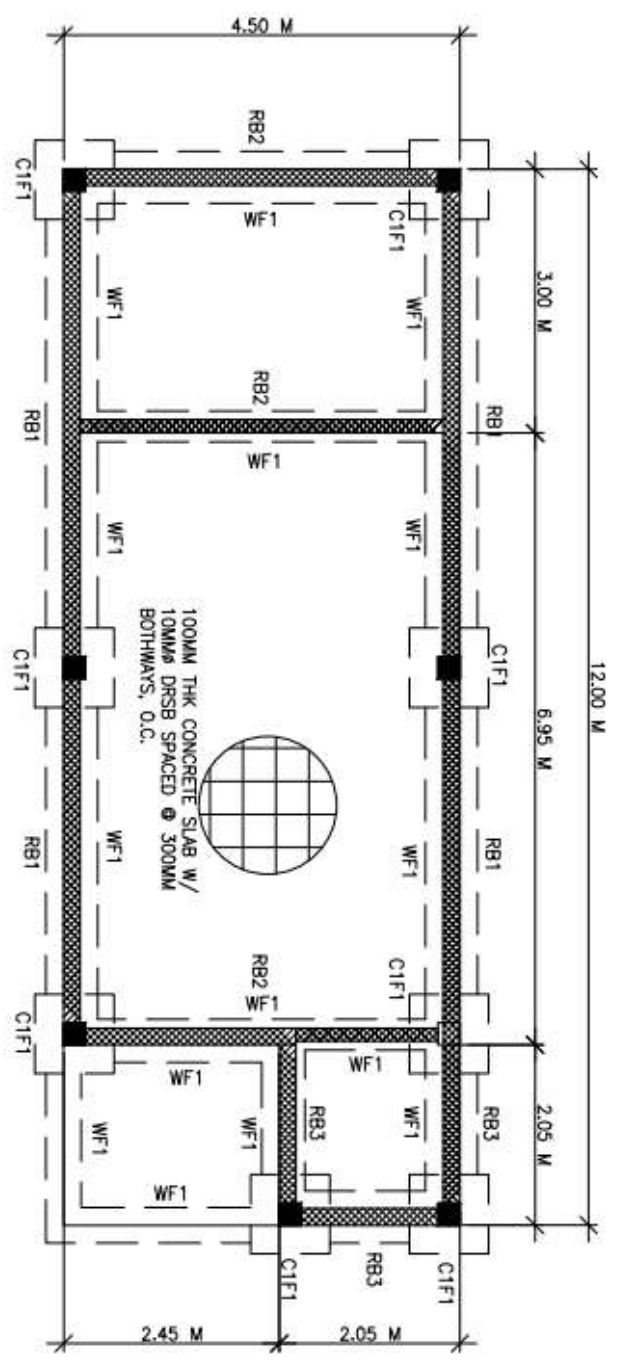

FOUNDATION PLAN

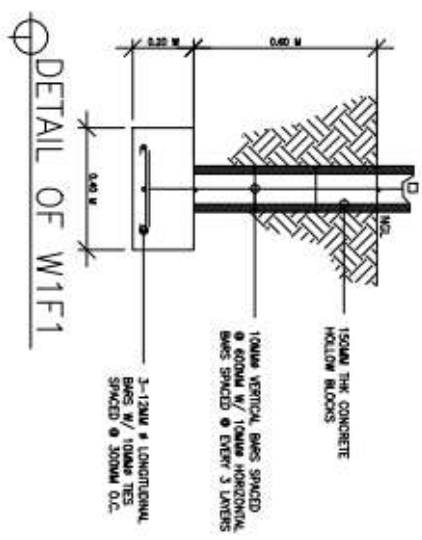
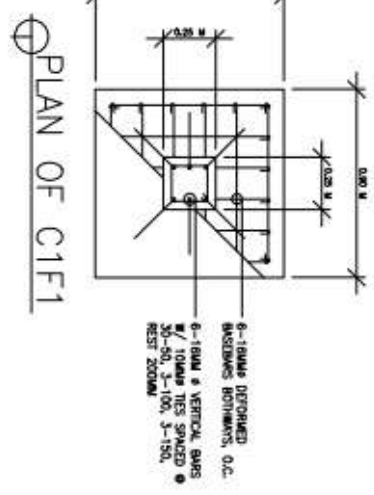
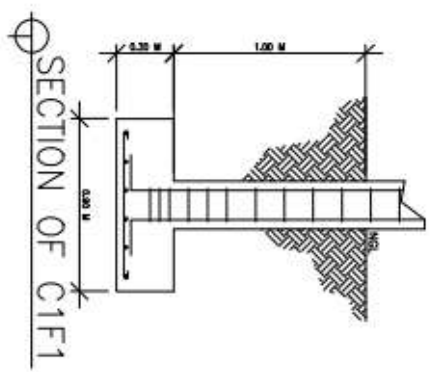

NATIONAL UNIVERSITY OF SCIENCE AND TECHNOLOGY INSTITUTIONAL ENGINEERING DEPARTMENT	
THESE DRAWINGS ARE THE PROPERTY OF THE INSTITUTION AND ARE NOT TO BE REPRODUCED OR TRANSMITTED IN ANY FORM OR BY ANY MEANS, ELECTRONIC OR MECHANICAL, INCLUDING PHOTOCOPYING, RECORDING, OR BY ANY INFORMATION STORAGE AND RETRIEVAL SYSTEM, WITHOUT THE WRITTEN PERMISSION OF THE INSTITUTION.	
APPROVED FOR DEVELOPMENT AND IMPLEMENTATION SERVICES INSTITUTIONAL ENGINEERING DEPARTMENT NATIONAL UNIVERSITY OF SCIENCE AND TECHNOLOGY	
DRAWING NO: NUST/IEE/2018/001	SHEET NO: 01 OF 01
PROJECT:	BUILDING:
CLIENT:	ADDRESS:
DATE:	SCALE:
DRAWN BY:	CHECKED BY:
DESIGNED BY:	APPROVED BY:
INSTITUTIONAL ENGINEERING DEPARTMENT NATIONAL UNIVERSITY OF SCIENCE AND TECHNOLOGY	
GENERAL NOTES: 1. ALL DIMENSIONS ARE IN METERS UNLESS OTHERWISE SPECIFIED. 2. REINFORCEMENT SHALL BE AS PER IS: 456-2000. 3. CONCRETE SHALL BE AS PER IS: 456-2000. 4. ALL WALLS SHALL BE 100MM THICK UNLESS OTHERWISE SPECIFIED. 5. ALL WALLS SHALL BE FINISHED WITH 10MM THICK PLASTER ON BOTH SIDES. 6. ALL WALLS SHALL BE FINISHED WITH 10MM THICK POLISHED PLASTER ON BOTH SIDES. 7. ALL WALLS SHALL BE FINISHED WITH 10MM THICK POLISHED PLASTER ON BOTH SIDES. 8. ALL WALLS SHALL BE FINISHED WITH 10MM THICK POLISHED PLASTER ON BOTH SIDES. 9. ALL WALLS SHALL BE FINISHED WITH 10MM THICK POLISHED PLASTER ON BOTH SIDES. 10. ALL WALLS SHALL BE FINISHED WITH 10MM THICK POLISHED PLASTER ON BOTH SIDES.	
STRUCTURAL PLAN AS SHOWN	DATE:

Section VIII. Bill of Quantities

Notes on the Bill of Quantities

Objectives

The objectives of the Bill of Quantities are:

- a. to provide sufficient information on the quantities of Works to be performed to enable Bids to be prepared efficiently and accurately; and
- b. when a Contract has been entered into, to provide a priced Bill of Quantities for use in the periodic valuation of Works executed.

In order to attain these objectives, Works should be itemized in the Bill of Quantities in sufficient detail to distinguish between the different classes of Works, or between Works of the same nature carried out in different locations or in other circumstances which may give rise to different considerations of cost. Consistent with these requirements, the layout and content of the Bill of Quantities should be as simple and brief as possible.

Daywork Schedule

A Daywork Schedule should be included only if the probability of unforeseen work, outside the items included in the Bill of Quantities, is high. To facilitate checking by the Entity of the realism of rates quoted by the Bidders, the Daywork Schedule should normally comprise the following:

- a. A list of the various classes of labor, materials, and Constructional Plant for which basic daywork rates or prices are to be inserted by the Bidder, together with a statement of the conditions under which the Contractor will be paid for work executed on a daywork basis.
- b. Nominal quantities for each item of Daywork, to be priced by each Bidder at Daywork rates as Bid. The rate to be entered by the Bidder against each basic Daywork item should include the Contractor's profit, overheads, supervision, and other charges.

Provisional Sums

A general provision for physical contingencies (quantity overruns) may be made by including a provisional sum in the Summary Bill of Quantities. Similarly, a contingency allowance for possible price increases should be provided as a provisional sum in the Summary Bill of Quantities. The inclusion of such provisional sums often facilitates budgetary approval by avoiding the need to request periodic supplementary approvals as the future need arises. Where such provisional sums or contingency allowances are used, the SCC should state the manner in which they will be used, and under whose authority (usually the Procuring Entity's Representative's).

The estimated cost of specialized work to be carried out, or of special goods to be supplied, by other contractors should be indicated in the relevant part of the Bill of Quantities as a particular provisional sum with an appropriate brief description. A separate procurement procedure is normally carried out by the Procuring Entity to select such specialized contractors. To provide an element of competition among the Bidders in respect of

any facilities, amenities, attendance, etc., to be provided by the successful Bidder as prime Contractor for the use and convenience of the specialist contractors, each related provisional sum should be followed by an item in the Bill of Quantities inviting the Bidder to quote a sum for such amenities, facilities, attendance, etc.

Signature Box

A signature box shall be added at the bottom of each page of the Bill of Quantities where the authorized representative of the Bidder shall affix his signature. Failure of the authorized representative to sign each and every page of the Bill of Quantities shall be a cause for rejection of his bid.

These Notes for Preparing a Bill of Quantities are intended only as information for the Procuring Entity or the person drafting the Bidding Documents. They should not be included in the final documents.

NAME OF PROJECT :		Construction of CSIS Office					
LOCATION :		Plaridel Airport, Plaridel, Bulacan					
						QUANTITY	UNIT
SUBJECT :				Bill of Quantities		1.00	lot
ITEM	DESCRIPTION	QUANTITY	UNIT	UNIT COST	AMOUNT (P)		
1.00	CIVIL/STRUCTURAL WORKS						
1.01	Removal Works						
A	Materials						
	Demolition of Existing Structure and Ground Slab	26.19	cu.m.				
	Excavation	20.00	cu.m.				
	Backfill	15.00	cu.m.				
	Gravel, G1	2.00	cu.m.				
	Common Borrow (<i>Embankment, delivered on site</i>)	9.00	cu.m.				
	Soil Poisoning	13.00	gals				
	Diamond Blade Cutter 14" Ø	1.00	pcs				
				Material Cost		
B	Labor	QTY.	DUR. (DAYS)	RATE/DAY			
	Project (Civil) Engineer	1.00	7				
	Construction Foreman	1.00	7				
	Skilled Worker	2.00	7				
	Common Worker	4.00	7				
				Labor Cost		
C	Equipment	QTY.	DUR. (DAYS)	RATE/DAY			
	Air Compressor and Jackhammer	1.00	5				
	Concrete Saw, Blade 14" diameter	1.00	1				
	Plate Compactor	1.00	1				
				Equipment Cost		
	Site Works Material Cost						
	Site Works Labor Cost						
	Site Works Equipment Cost						
	Site Works Direct Cost						
1.02	Concrete Works						
A	Materials						
	Portland Cement	163.00	bags				
	Sand	9.00	cu.m.				
	Gravel, 3/4"	17.00	cu.m.				
	16mm dia. DRSB, 6meters	115.00	pcs				
	12mm dia. DRSB, 6meters	19.00	pcs				
	10mm dia. DRSB, 6meters	165.00	pcs				
	#16 GI Tie Wire	29.00	kgs				
	1/2" x 4' x 8' Ordinary Plywood	17.00	pcs				
	Form Lumber	1,014.00	bd.ft				
	Assorted CWN	19.00	kgs				
				Material Cost		
B	Labor	QTY.	DUR. (DAYS)	RATE/DAY			
	Project (Civil) Engineer	1.00	10				
	Construction Foreman	1.00	18				
	Skilled Worker	2.00	18				
	Common Worker	4.00	18				
				Labor Cost		

C	Equipment		QTY.	DUR. (DAYS)	RATE/DAY	
	One-bagger Concrete Mixer		1.00	3		
	Concrete Vibrator		1.00	3		
					Equipment Cost
	Concrete Works Material Cost					
	Concrete Works Labor Cost					
	Concrete Works Equipment Cost					
	Concrete Works Direct Cost					
1.03	Masonry Works (including Plastering)					
A	Materials					
	150mm thick CHB		1,188.00	pcs.		
	Portland Cement (40kg)		124.00	bags		
	Sand		11.00	cu.m.		
	10mm dia. DRSB, 6meters		67.00	pcs.		
	#16 GI Tie Wire		4.00	kgs.		
					Material Cost
B	Labor		QTY.	DUR. (DAYS)	RATE/DAY	
	Project (Civil) Engineer		1.00	3		
	Construction Foreman		1.00	6		
	Skilled Worker		2.00	6		
	Common Worker		4.00	6		
					Labor Cost
	Masonry Works Material Cost					
	Masonry Works Labor Cost					
	Masonry Works Direct Cost					
1.04	Steel Works					
A	Materials					
	(Roof Frame, including Guard Post roof frame)					
	3" Ø x 6m G.I. Steel Pipe, Sch. 40		1.00	pcs.		
	1 1/2" x 10mmØ Anchor bolt with washers		68.00	pcs.		
	1 1/2" x 12mmØ Anchor bolt with washers		84.00	pcs.		
	50mm x 50mm x 4.76mm x 6m. Angle bar		19.00	pcs.		
	44mm x 44mm x 4.76mm x 6m. Angle bar		11.00	pcs.		
	32mm x 32mm x 4.76mm x 6m. Angle bar		4.00	pcs.		
	25mm x 25mm x 4.76mm x 6m. Angle bar		3.00	pcs.		
	100mm x 50mm x 1.5mm x 6m. C-purlins		24.00	pcs.		
	50mm x 50mm x 1.5mm x 6m. C-purlins		3.00	pcs.		
	6mm thk. Gusset Plate (1.2m x 2.4m)		2.00	pcs.		
	10mm thk. Base Plate (1.2m x 2.4m)		1.00	pc.		
	Welding rod E6011		10.00	kgs		
	Oxygen		3.00	cyl		
	Acetylene		3.00	cyl		
					Material Cost
B	Labor		QTY.	DUR. (DAYS)	RATE/DAY	
	Construction Foreman		1.00	9		
	Skilled Worker		1.00	9		
	Common Worker		2.00	9		
					Labor Cost

		QTY.	DUR. (DAYS)	RATE/DAY	
C	Equipment				
	Welding Machine	1.00	9		
	Portable Generator Set	1.00	9		
	Oxy-Acetylene Cutting Torch/Welding Outfit	1.00	9		
				Equipment Cost
	Steel Works Material Cost				
	Steel Works Labor Cost				
	Steel Works Equipment Cost				
	Steel Works Direct Cost				
1.05	Roofing Works				
A	Materials				
	GA #24 Longspan Rib-type Pre-painted Roofing Sheet	138.00	ln.m.		
	G.I Gutter GA #24, Pre-painted	18.00	pcs.		
	G.I Valley Roll GA #24 (0.50mm thk x 0.610m x 2.44m), Pre-painted	2.00	pcs.		
	G.I Flushing GA #24 (0.50mm thk x 0.915m x 2.44m), Pre-painted	2.00	pcs.		
	G.I Ridge Cap GA #26 (0.40mm thk x 0.610m x 2.44m), Pre-painted	14.00	pcs.		
	Polyethylene foam w/ one side aluminum (10mm x 1m x50m)	2.00	pcs.		
	Roof Sealant	10.00	tubes		
	Teksrew	1,350.00	pcs.		
	Blind Rivet 1/8" dia.	1,350.00	pcs.		
				Material Cost
B	Labor	QTY.	DUR. (DAYS)	RATE/DAY	
	Construction Foreman	1.00	9		
	Skilled Worker	2.00	9		
	Common Worker	4.00	9		
				Labor Cost
	Roofing Works Material Cost				
	Roofing Works Labor Cost				
	Roofing Works Equipment Cost				
	Roofing Works Direct Cost				
1.06	Catch Basin				
A	Materials				
	100mm thick CHB	24.00	pcs.		
	Portland Cement	6.00	bags		
	Sand	3.00	cu.m.		
	Gravel, 3/4"	1.00	cu.m.		
	10mm dia. DRSB, 6meters	16.00	pcs.		
	12mm dia. Lifting Handle with 16mm Bolts	5.00	sets		
	G.I. Tie Wires	1.00	kgs.		
	1/2" x 4' x 8' Ordinary Plywood	1.00	pcs.		
	Form Lumber	23.00	bd.ft.		
	Assorted CWN	1.00	kg.		
				Material Cost
B	Labor	QTY.	DUR. (DAYS)	RATE/DAY	
	Construction Foreman	1.00	2		
	Skilled Worker	1.00	2		
	Common Worker	2.00	2		
				Labor Cost
	Septic Tank Material Cost				
	Septic Tank Labor Cost				
	Septic Tank Direct Cost				

A	TOTAL MATERIAL COST						
B	TOTAL LABOR COST						
C	TOTAL EQUIPMENT						
D	TOTAL DIRECT COST						
INDIRECT COSTS							
1. OCM (0% - 15% of TDC)		15.0%	of Estimated Direct Cost				
2. CONTRACTOR'S PROFIT (0% - 10% of TDC)		10.0%	of Estimated Direct Cost				
E. TOTAL OCM & PROFIT		25.0%	of D				
F. VALUE ADDED TAX, (VAT)		5.0%	of (D + E)				
G. TOTAL ESTIMATED INDIRECT COST (F + E), P							
H. TOTAL ESTIMATED UNIT INDIRECT COST (G / Quantity), P/Unit							
TOTAL ESTIMATED COST (D + G), P							
TOTAL ESTIMATED UNIT COST (Total Estimated Cost / Quantity), P/Unit							

NAME OF PROJECT :		Construction of CSIS Office					
LOCATION :		Plaridel Airport, Plaridel, Bulacan					
						QUANTITY	UNIT
SUBJECT :				Bill of Quantities		1.00	lot
ITEM	DESCRIPTION			QUANTITY	UNIT	UNIT COST	AMOUNT (P)
2.00	ARCHITECTURAL WORKS						
2.01	Tile Works			50.55	sq.m.		
A	Materials						
	600mm x 600mm Homogenous Floor Tiles Polished Finish			116.00	pcs.		
	300mm x 300mm Homogenous Floor Tiles			36.00	pcs.		
	300mm x 300mm Homogenous Wall Tiles			87.00	pcs.		
	600mm x 600mm Homogenous Polished Tiles (kitchen countertop)			2.00	pcs.		
	Tile Trim, 8ft.			7.00	pcs.		
	Tile Adhesive (25kgs)			15.00	bags		
	Tile Grout (2kgs)			11.00	bags		
	Diamond Cutting Disk, 4"			2.00	pcs.		
					Material Cost	
B	Labor			QTY.	DUR. (DAYS)	RATE/DAY	
	Project (Civil) Engineer			1.00	2		
	Construction Foreman			1.00	4		
	Skilled Worker			2.00	4		
	Common Worker			4.00	4		
					Labor Cost	
C	Equipment			QTY.	DUR. (DAYS)	RATE/DAY	
	Angle Grinder			1.00	4		
					Equipment Cost	
Tile Works Material Cost							
Tile Works Labor Cost							
Tile Works Equipment Cost							
Tile Works Direct Cost							
2.02	Carpentry Works						
A	Materials						
2.02.01	<i>Dry Wall, Ceiling and Fascia Board</i>			119.78	sq.m.		
	<i>Dry Wall</i>						
	4 'x 8' x 6mm thk. Fiber Cement Board			9.00	pcs.		
	32mmx64mmx3mx0.6mm thk. Metal Stud			9.00	pcs.		
	32mmx64mmx3mx0.6mm thk. Metal Tracks			5.00	pcs.		
	Needle Point Screw 38mm w/ plastic insert			17.00	pcs.		
	Self Drilling Point Screw 10mm			57.00	pcs.		
	<i>Ceiling and Fascia Board</i>						
	4 'x 8' x 4.5mm thk. Fiber Cement Board			31.00	pcs.		
	Wall Angle (0.6mm thk x 25mm x 25mm x 3m)			40.00	pcs.		
	Double Furring (0.6mm thk x 19mmx50mmx5m)			40.00	pcs.		
	Carrying Channel (12mm x 38mm x 5m)			19.00	pcs.		
	W-Clip			257.00	pcs.		
	Flat Head Screw 20mm			2,370.00	pcs.		
	Metal Screw 32mm with plastic insert			295.00	pcs.		
	Blind Rivets			3.00	boxes		

	Rod Suspension Hanger with Adjustment Spring	81.00	pcs.		
	Fiber Cement Board Perforated Tape (250ft/roll)	3.00	rolls		
	Fiber Cement Board Putty (25kg per pc.)	4.00	pcs.		
	1' x 4' Air Ventilation L-Type	4.00	pcs.		
	Insect Screen	4.00	meters		
	Fascia Board 12mm x 12" x 12ft.	10.00	pcs.		
	Drill Bit	10.00	pcs.		
	Cutting Disc 4"	5.00	pcs.		
	Assorted Concrete Nails	2.00	kgs		
			Material Cost	
B	Labor	QTY.	DUR. (DAYS)	RATE/DAY	
	Project (Civil) Engineer	1.00	12		
	Construction Foreman	1.00	12		
	Skilled Worker	2.00	12		
	Common Worker	2.00	12		
			Labor Cost	
C	Equipment	QTY.	DUR. (DAYS)	RATE/DAY	
	Scaffolding Set	4.00	12		
	Electric Hand Drill	2.00	12		
			Equipment Cost	
	Carpentry Works Material Cost				
	Carpentry Works Labor Cost				
	Carpentry Works Equipment Cost				
	Carpentry Works Direct Cost				
2.03	Painting Works				
A	Materials				
2.03.01	<i>Paint Finish for Exterior Wall, Interior Wall, Ceiling and Fascia Board</i>	<i>290.39</i>	<i>sq.m.</i>		
	Flat Latex White Paint	14.00	gals		
	Semi Gloss Latex Paint	25.00	gals		
	Skimcoat (20kg)	24.00	bags		
	Acry Color (1/4 liter)	5.00	pcs.		
	Paint thinner	1.00	gals		
	Paint Roller with pan 7"	10.00	pcs.		
	Paint Brush 4"	10.00	pcs.		
	Paint Brush 2"	10.00	pcs.		
	Assorted Sand Paper	200.00	pcs.		
	Rugs	5.00	kgs		
2.03.02	<i>Paint Finish for Doors and other steel finishes</i>	<i>14.60</i>	<i>sq.m.</i>		
	Flatwall Enamel Paint	2.00	gals		
	Quick Dry Enamel Paint	7.00	gals		
	Glazing Putty	2.00	gals		
	Red Oxide Primer	4.00	gals		
	Paint thinner	2.00	gals		
	Baby Roller with handle	4.00	pcs.		
	Paint Brush 4"	4.00	pcs.		
	Paint Brush 2"	4.00	pcs.		
	Assorted Sand Paper	30.00	pcs.		
	Rugs	1.00	kgs		
			Material Cost	

		QTY.	DUR. (DAYS)	RATE/DAY
B	Labor			
	Construction Foreman	1.00	3	
	Skilled Worker	2.00	7	
	Common Worker	4.00	7	
			Labor Cost
	Painting Works Material Cost			
	Painting Works Labor Cost			
	Painting Works Equipment Cost			
	Painting Works Direct Cost			
2.04	Doors and Windows			
A	Materials			
	<i>Doors</i>	4.00	sets	
	D-1 900mm x 2100mm Wood Type Panel door w/ jamb, Painted finish (with complete door hardware and accessories)	2.00	sets	
	D-2 700mm x 2100mm Wood Type Flush door w/ jamb, Painted finish (with complete door hardware and accessories)	2.00	sets	
	<i>Windows</i>	5.00	sets	
	W-1 1500mm x 1200mm 1/4"thk Clear glass sliding window on analog window frame with screen (with complete window hardware and accessories)	4.00	sets	
	W-2 600mm x 600mm 1/4"thk Clear Glass Awning Window on Analog window frame (with complete window hardware and accessories)	1.00	set	
			Material Cost
B	Labor	QTY.	DUR. (DAYS)	RATE/DAY
	Project (Civil) Engineer	1.00	2	
	Construction Foreman	1.00	5	
	Skilled Worker	2.00	5	
	Common Worker	2.00	5	
			Labor Cost
	Doors and Windows Material Cost			
	Doors and Windows Labor Cost			
	Doors and Windows Direct Cost			
A	TOTAL MATERIAL COST			
B	TOTAL LABOR COST			
C	TOTAL EQUIPMENT COST			
D	TOTAL DIRECT COST			
INDIRECT COSTS				
	1. OCM (0% - 15% of TDC)	15.0%	of Estimated Direct Cost	
	2. CONTRACTOR'S PROFIT (0% - 10% of TDC)	10.0%	of Estimated Direct Cost	
	E. TOTAL OCM & PROFIT	25.0%	of D	
	F. VALUE ADDED TAX, (VAT)	5.0%	of (D + E)	
	G. TOTAL ESTIMATED INDIRECT COST (F + E), P			
	H. TOTAL ESTIMATED UNIT INDIRECT COST (G / Quantity), P/Unit			
	TOTAL ESTIMATED COST (D + G), P			
	TOTAL ESTIMATED UNIT COST (Total Estimated Cost / Quantity), P/Unit			

NAME OF PROJECT :		Construction of CSIS Office				
LOCATION :		Plaridel Airport, Plaridel, Bulacan				
					QUANTITY	UNIT
SUBJECT :				Bill of Quantities		
				1.00	lot	
ITEM	DESCRIPTION	QUANTITY	UNIT	UNIT COST	AMOUNT (P)	
3.00	ELECTRICAL WORKS					
A	Materials					
3.01	Conduits					
	1/2" x 3m Electrical PVC Pipe	20.00	pcs			
	3/4" x 3m Electrical PVC Pipe	20.00	pcs			
	1" x 3m PVC Pipe	5.00	pcs			
3.02	Conduit Fittings					
	1/2" PVC Male Adapter with Locknut	30.00	pcs			
	3/4" PVC Male Adapter with Locknut	30.00	pcs			
	1" Service Entrance Cap	1.00	pcs			
3.03	Wires and Cables					
	2.0mm ² THWN/THHN Copper Wire (black)	2.00	box			
	3.5mm ² THWN/THHN Copper Wire (black)	1.00	box			
	14mm ² THWN/THHN Copper Wire (balck)	60.00	meters			
3.04	Electrical Wiring Devices					
	Duplex Convenience Outlet with plate and bracket - 15A, 250V, Universal type w/ ground	9.00	set			
	1 Gang Aircon Outlet Set	2.00	set			
	2-gang switch with plate and bracket	2.00	set			
	3-gang switch with plate and bracket	1.00	set			
	Ground Fault Circuit Interrupter Outlet (GFCI)	1.00	set			
3.05	Lighting Fixtures					
	LED Panel Light surface mount 24W 120cm x 30cm	6.00	pcs			
	LED Panel Light surface mount 24W 60cm x 60cm	1.00	pcs			
	Outdoor LED Pinlight 12Watts	5.00	pcs			
3.06	Ventilation					
	30 Watts Ceiling Mounted Exhaust Fan	1.00	pcs			
3.07	Boxes and Pullboxes					
	PVC Octagonal Junction Box	12.00	pcs			
	4" x 2" PVC Utility Box for 1/2" PVC Pipe	5.00	pcs			
	4" x 2" PVC Utility Box for 3/4" PVC Pipe	15.00	pcs			
	PVC Pull Box 4" x 6" x 6"	2.00	pcs			
3.08	LPP / Circuit Breaker					
	6 Branch Lighting and Power Panel Board 1 dia, 2W, 240/120V, 60Hz, with Ground Main: 100AT, 100AF, 2-Pole, 240V, 10KAIC MCCB Branches: 2x30AT, 2-Pole, 10KAIC, 230V Bolt on Type 2x20AT, 2-Pole, 10 KAIC, 230V, Bolt on Type	1.00	assy			

	Enclosure: NEMA-1					
	Materials: G.I. #16					
	Finished: Powder Coated Gray Finish					
	Panel Features: Pushlock, Grounding Lugs, Neutral Lugs, Bolted Dead Front, Directory Holder					
3.09	Termination Accessories					
	Electrical Tape, 19mm x 0.19mm x 16m		5.00	pcs		
	G.I. Tie Wire GA 16		2.00	kg		
	Rubber Tape		1.00	pc		
	PVC Cement (100cc)		2.00	pc		
3.1	Hangers and Supports					
	Conduit hanger clamp for 1/2"		50.00	pcs		
	Conduit hanger clamp for 3/4"		50.00	pcs		
	Conduit hanger clamp for 1"		10.00	pcs		
				Material Cost	
B	Labor		QTY.	DUR. (DAYS)	RATE/DAY	
	Electrician		2.00	15		
				Labor Cost	
A	TOTAL MATERIAL COST					
B	TOTAL LABOR COST					
D	TOTAL DIRECT COST					
INDIRECT COSTS						
	1. OCM (0% - 15% of TDC)		15.0%	of Estimated Direct Cost		
	2. CONTRACTOR'S PROFIT (0% - 10% of TDC)		10.0%	of Estimated Direct Cost		
E.	TOTAL OCM & PROFIT		25.0%	of D		
F.	VALUE ADDED TAX, (VAT)		5.0%	of (D + E)		
G.	TOTAL ESTIMATED INDIRECT COST (F + E), P					
H.	TOTAL ESTIMATED UNIT INDIRECT COST (G / Quantity), P/Unit					
	TOTAL ESTIMATED COST (D + G), P					
	TOTAL ESTIMATED UNIT COST (Total Estimated Cost / Quantity), P/Unit					

NAME OF PROJECT :		Construction of CSIS Office				
LOCATION :		Paridel Airport, Paridel, Bulacan				
				QUANTITY	UNIT	
SUBJECT :		Bill of Quantities		1.00	lot	
ITEM	DESCRIPTION	QUANTITY	UNIT	UNIT COST	AMOUNT (P)	
4.00	MECHANICAL WORKS					
A	Materials					
4.01	Air Conditioning Unit					
	1.0 HP, Dual Inverter Compressor, 70% Energy Saving, Fast Cooling, Low Noise, Auto Clean, Active Energy Control Split Type ACU w/ complete standard accessories (Circuit breaker protection in NEMA 3R Enclosure, Copper tubing, pipes, rubber insulations, ACCU metal bracket platform, hangers & supports, wall mounted slimduct line set ducting system and other standard fittings), Power Supply: 230V 1Ø, 60 Hz, Refrigerant Type: R32, included labor installation.	1.00	set			
	2.0 HP, Dual Inverter Compressor, 70% Energy Saving, Fast Cooling, Low Noise, Auto Clean, Active Energy Control, Split Type Air Conditioning Unit with complete standard accessories (Circuit breaker protection in NEMA 3R Enclosure, Copper tubing, rubber insulations, ACCU metal bracket platform, hangers & supports, wall mounted slimduct line set ducting system and other standard fittings), Power Supply: 230V 1Ø, 60 Hz, Refrigerant Type: R32, included labor installation.	1.00	set			
				Material Cost	
A	TOTAL MATERIAL COST					
B	TOTAL LABOR COST					
D	TOTAL DIRECT COST					
INDIRECT COSTS						
	1. OCM (0% - 15% of TDC)	15.0%	of Estimated Direct Cost			
	2. CONTRACTOR'S PROFIT (0% - 10% of TDC)	10.0%	of Estimated Direct Cost			
	E. TOTAL OCM & PROFIT	25.0%	of D			
	F. VALUE ADDED TAX, (VAT)	5.0%	of (D + E)			
	G. TOTAL ESTIMATED INDIRECT COST (F + E), P					
	H. TOTAL ESTIMATED UNIT INDIRECT COST (G / Quantity), P/Unit					
	TOTAL ESTIMATED COST (D + G), P					
	TOTAL ESTIMATED UNIT COST (Total Estimated Cost / Quantity), P/Unit					

NAME OF PROJECT :		Construction of CSIS Office					
LOCATION :		Plaridel Airport, Plaridel, Bulacan					
						QUANTITY	UNIT
SUBJECT :		Bill of Quantities				1.00	lot
ITEM	DESCRIPTION	QUANTITY	UNIT	UNIT COST	AMOUNT (P)		
5.00	PLUMBING WORKS						
A	Materials						
5.01	Fixtures						
	Water Closet; American White color, elongated bowl, Vitreous China; Grade A, dual flush push button flush type mechanism, with complete fittings	1.00	set				
	Bidet spray w/ complete accessories, Chrome plated ABS body	1.00	set				
	Lavatory; American White color, countertop installation type, Vitreous China; Grade A, with complete accessories and fittings	1.00	set				
	Urinal; American White color, Wall hung installation type, Top Inlet type, including Flush valve fitting for urinal, Vitreous China; Grade A, with complete accessories and fittings	1.00	set				
	Wash Basin Faucet; Brass with Chrome Finish, Quarter turn lever lavatory sink faucet, with complete fittings and accessories	1.00	pcs.				
	Soap Holder; Wall mounted, American White color, Vitreous China; Grade A	1.00	pcs.				
	Toilet Paper Holder; Wall mounted, American White color, Vitreous China; Grade A	1.00	pcs.				
	Floor drain, 100mm x 100mm, stainless steel	1.00	pcs.				
5.02	Sewerline						
	4"Ø PVC Pipe (Series 600), 3meters	2.00	pcs.				
	4"Ø x 2"Ø PVC Wye Reducer	3.00	pcs.				
	4"Ø PVC Wye	3.00	pcs.				
	4"Ø PVC Tee	3.00	pcs.				
	2"Ø PVC Pipe (Series 600), 3meters	3.00	pcs.				
	2"Ø PVC P-trap	4.00	pcs.				
	2"Ø x 2"Ø PVC 90deg. Elbow	5.00	pcs.				
	2"Ø x 2"Ø PVC Coupling	3.00	pc.				
	2"Ø PVC Wye	3.00	pcs.				
	2"Ø PVC Tee	3.00	pcs.				
	Solvent Cement (400cc)	1.00	can				
5.03	Waterline						
	1/2"Ø PVC Pipe	3.00	pcs.				
	1/2"Ø PVC 90deg. Elbow	5.00	pcs.				
	1/2"Ø PVC 90deg. Threaded Elbow	4.00	pcs.				
	1/2"Ø x 1/2"Ø PVC Tee	5.00	pcs.				
	1/2"Ø PVC Coupling	5.00	pcs.				
	1/2"Ø PVC End Cap	3.00	pcs.				
	1/2"Ø PVC Plug	3.00	pcs.				
	1/2"Ø x 1/2"Ø Angle Valve	2.00	pcs.				
	1/2"Ø x 1/2"Ø Two-way Angle Valve	1.00	pcs.				
	1/2"Ø x 1/2"Ø x 16" Flexible Supply Pipe	3.00	pcs.				
	Teflon Tape	15.00	pcs.				
	Solvent S-Blue (1/8 Liter)	2.00	pcs.				

5.04	Downspout						
	3"Ø PVC Pipe, 3 meters			19.00	pcs.		
	3"Ø PVC 90deg. Elbow			15.00	pcs.		
	Solvent Cement (400cc)			1.00	cans		
					Material Cost	
B	Labor			QTY.	DUR. (DAYS)	RATE/DAY	
	Plumber			1.00	5		
	Common Worker			1.00	5		
					Labor Cost	
A	TOTAL MATERIAL COST						
B	TOTAL LABOR COST						
D	TOTAL DIRECT COST						
INDIRECT COSTS							
	1. OCM (0% - 15% of TDC)		15.0%	of Estimated Direct Cost			
	2. CONTRACTOR'S PROFIT (0% - 10% of TDC)		10.0%	of Estimated Direct Cost			
	E. TOTAL OCM & PROFIT		25.0%	of D			
	F. VALUE ADDED TAX, (VAT)		5.0%	of (D + E)			
	G. TOTAL ESTIMATED INDIRECT COST (F + E), P						
	H. TOTAL ESTIMATED UNIT INDIRECT COST (G / Quantity), P/Unit						
	TOTAL ESTIMATED COST (D + G), P						
	TOTAL ESTIMATED UNIT COST (Total Estimated Cost / Quantity), P/Unit						

NAME OF PROJECT :		Construction of CSIS Office					
LOCATION :		Plaridel Airport, Plaridel, Bulacan					
						QUANTITY	UNIT
SUBJECT :		Bill of Quantities				1.00	lot
ITEM	DESCRIPTION			QUANTITY	UNIT	UNIT COST	AMOUNT (P)
6.00	FURNITURE						
A	Materials						
	Executive Table			1.00	unit		
	Material: MDF						
	Color: Beech, Black or Dark Gray						
	Dimension: L 160 x W 80 x H 75 cm						
	Executive Chair			1.00	unit		
	Material: Synthetic Leather + Chrome Base						
	Color: Black						
	Dimension: L 25.5" x W 22" x H 43"						
	Adjustable to H 47"						
					Material Cost	
A	TOTAL MATERIAL COST						
INDIRECT COSTS							
1. OCM (0% - 15% of TDC)		0.0%		of Estimated Direct Cost			
2. CONTRACTOR'S PROFIT (0% of TDC)		10.0%		of Estimated Direct Cost			
E. TOTAL OCM & PROFIT		10.0%		of D			
F. VALUE ADDED TAX, (VAT)		5.0%		of (D + E)			
G. TOTAL ESTIMATED INDIRECT COST (F + E), P							
H. TOTAL ESTIMATED UNIT INDIRECT COST (G / Quantity), P/Unit							
TOTAL ESTIMATED COST (D + G), P							
TOTAL ESTIMATED UNIT COST (Total Estimated Cost / Quantity), P/Unit							

Section IX. Bidding Forms

TABLE OF CONTENTS

OTHER BIDDING FORMS(ANNEX“ A”)	48
OTHER BIDDING FORMS(ANNEX“ B”)	54
OTHER BIDDING FORMS(ANNEX“ C”)	72
OTHER BIDDING FORMS(ANNEX“ D”)	80

Other Bidding Forms

(ANNEX "A")

ANNEX "A"FORM1	STATEMENT OF ALL ON-GOING CONTRACTS
ANNEX "A"FORM2	STATEMENT OF SINGLE LARGEST COMPLETED CONTRACT
ANNEX "A"FORM3	JOINT RESOLUTION FORM FOR JVA

{ATTACH COMPANY LETTERHEAD/LOGO}

Statement of all its ON-GOING government and private contracts, including contracts awarded but not yet started, if any, whether similar or not similar in nature and complexity to the contract to be bid

Name of Project: _____

Location of Project: _____

Name of Company: _____

Address of Company: _____

Name of Contract	a. Owner's Name b. Address c. Telephone No.	Nature of Work	Contractor's Role		Contract Amount at Award	a. Date Awarded b. Date of Contract c. Contract Duration d. Date Started e. Date Completed	Accomplishment		Values of Outstanding Works
			Description	%			Planned	Actual	
Government									
Private									
								Total value of outstanding works	

Submitted by: _____

(Print Name & Signature)

Designation: _____

Date: _____

{ ATTACH COMPANY LETTERHEAD/LOGO }

Statement of single largest COMPLETED contract similar to the contract to be bid

Name of Project: _____

Location of Project: _____

Name of Company: _____

Address of Company: _____

Name of Contract	a. Owner's Name b. Address c. Telephone No.	Nature of Work	Contractor's Role		Contract Amount at Award	a. Date Awarded b. Date of Contract c. Contract Duration d. Date Started e. Date Completed
			Description	%		

Submitted by: _____

(Print Name & Signature)

Designation: _____

Date: _____

JOINT RESOLUTION

Whereas, _____ (Bidder / Name of Particular JV Partner), duly organized and existing under the Laws of the _____, with office address at _____, represented herein by its _____, _____, and _____ (Name of Particular JV Partner), duly organized and existing under the Laws of the _____, with main office address at _____, represented by herein by its _____, have entered into a Joint Venture (JV) Agreement to undertake the following project /contract:

(Name of Project / Contract)

Whereas, in order to facilitate the orderly execution and conduct of the contract that was entered into by the joint venture in the name of the joint venture, it is hereby resolved by the parties in the Joint Venture as follows:

- a. To appoint _____ as the Authorized Managing Officer and Official Representative, to represent, to manage the Joint Venture and is empowered to enter in contract in the name of the Joint Venture, or to sign for any document in the name of the Joint Venture required by the (Procurement Agency) or any entities pursuant to the terms of the Joint Venture Agreement:
- b. That, the parties agreed to make _____ (Name of Particular Lead Partner) as the Lead Partner of the Joint Venture and (Name of Authorized Officer) _____ as the Official Representative & Managing Partner of the Joint Venture, and are granted full power and authority to do, execute and perform any and all acts necessary and/or to represent the Joint Venture in the Eligibility Check, Bidding and Undertaking of the said contract in the name of the Joint Venture, as fully and effectively and the Joint Venture may do and if personally present with full power of substitution and revocation. _____ is fully authorized and empowered to sign any or all documents pertaining to the above stated project / contract in the name of the Joint Venture.
- c. That the parties agree to be jointly and severally liable for their participation in the Eligibility Check, Bidding and Undertaking of the said contract.
- d. That the terms of the JV Agreement entered into the parties shall be valid and is co-terminus with the final completion and turnover of the Name of Contract /Project

to the agency of the government, which in this case, the (Name of Procurement Entity);

IN WITNESS THEREFORE, We hereby sign jointly this Joint Resolution this _____
Day of _____, 20____ in _____.

Name of Bidder (Lead Partner)

Name of Bidder (Member Partner)

By: _____

By: _____

Signature & Name of
Managing Officer

Signature & Name of Authorized
Representative

Designation/Position

Designation /Position

Name of Bidder (Member Partner)

Name of Bidder (Member Partner)

By: _____

By: _____

Signature & Name of
Managing Officer

Signature & Name of Authorized
Representative

Designation/Position

Designation /Position

SIGNED IN THE PRESENCE OF:

A C K N O W L E D G E M E N T

REPUBLIC OF THE PHILIPPINES)
CITY OF _____) S.S.

BEFORE ME, a Notary Public, for and in the City of _____, Philippines, this _____ day of _____, 20____ personally appeared the following persons:

NAME	Community Cert. No.	Date / Place of Issue
-------------	----------------------------	------------------------------

Representing to be the _____ of
_____ and _____ of
_____ respectively, known to me and

to me known to be the same persons who executed the foregoing instrument for and in behalf of said corporations and who acknowledge to me that same is their free and voluntary act and deed as well as of the corporations which they represent, for the uses, purposes, and considerations therein set forth and that they are duly authorized to sign the same.

This Instrument consists of THREE (3) pages including this page wherein this Acknowledgement is written and signed by the parties and their instrumental witnesses on each and every page thereon.

WITNESS MY HAND AND NOTARIAL SEAL at the place and date hereinafter first above written.

NOTARY PUBLIC

Doc. No. _____

Book No. _____

Page No. _____

Series of _____

Other Bidding Forms

(ANNEX “B”)

Annex “B”Form1	Certificate of Site Inspection
Annex “B”Form2	Bid Securing Declaration
Annex “B”Form3	Organizational Chart of Contract to be Bid
Annex “B”Form4	Qualification of Key Personnel Proposed to be Assigned in the Project
Annex “B”Form5a	Contractor's Letter-Certificate to Procuring Entity
Annex “B”Form5b	Key Personnel's Certificate of Employment
Annex “B”Form5c	Key Personnel (Format of Bio-Data)
Annex “B”Form6	List of Equipment Owned or Leased and/or under Purchased
Annex “B”Form7	Omnibus Sworn Statement



Republic of the Philippines
CIVIL AVIATION AUTHORITY OF THE PHILIPPINES

CERTIFICATE OF SITE INSPECTION

This is to CERTIFY that _____, employee of _____, has conducted the required Site Inspection for the bidding of the project " _____ " at _____.

Issued this _____, 2022

Airport Manager/Officer-in-Charge:

Signature over Printed Name

Bid-Securing Declaration

(REPUBLIC OF THE PHILIPPINES)
CITY OF _____) S.S.
X ----- X

Invitation to Bid *[Insert reference number]*

To: *[Insert name and address of the Procuring Entity]*

I/We, the undersigned, declare that:

1. I/We understand that, according to your conditions, bids must be supported by a Bid Security, which may be in the form of a Bid-Securing Declaration.
2. I/We accept that: (a) I/we will be automatically disqualified from bidding for any contract with any procuring entity for a period of two (2) years upon receipt of your Blacklisting Order; and, (b) I/we will pay the applicable fine provided under Section 6 of the Guidelines on the Use of Bid Securing Declaration, within fifteen (15) days from receipt of written demand by the procuring entity for the commission of acts resulting to the enforcement of the bid securing declaration under Sections 23.1(b), 34.2, 40.1 and 69.1, except 69.1 (f), of the IRR of RA 9184; without prejudice to other legal action the government may undertake.
3. I/We understand that this Bid-Securing Declaration shall cease to be valid on the following circumstances:
 - a. Upon expiration of the bid validity period, or any extension thereof pursuant to your request;
 - b. I am/we are declared ineligible or post-disqualified upon receipt of your notice to such effect, and (i) I/we failed to timely file a request for reconsideration or (ii) I/we filed a waiver to avail of said right;
 - c. I am/we are declared as the bidder with the Lowest Calculated Responsive Bid, and I/we have furnished the performance security and signed the Contract.

IN WITNESS WHEREOF, I/We have hereunto set my/our hand/s this _____ day of [month] [year] at [place of execution].

[Insert NAME OF BIDDER'S AUTHORIZED REPRESENTATIVE]
[Insert signatory's legal capacity]

Affiant

SUBSCRIBED AND SWORN to before me this day of [month] [year] at [place of execution], Philippines. Affiant/s is/are personally known to me and was/were identified by me through competent evidence of identity as defined in the 2004 Rules on Notarial Practice (A.M. No. 02-8-13-SC). Affiant/s exhibited to me his/her [insert type of government identification card used], with his/her photograph and signature appearing thereon, with no.

_____.

Witness my hand and seal this day of [month] [year].

NAME OF NOTARY PUBLIC

Serial No. of Commission
Notary Public for _____ **until** _____
Roll of Attorneys No. _____
PTR No., [date issued], [place issued]
IBP No., [date issued], [place issued]
Doc. No. _____
Page No. Book
No. Series of.

Contractor's Organizational Chart for the Project

Submit Copy of the Organizational Chart that the Contractor intends to use to execute the contract if awarded to him. Indicate in the chart the names of the Key Engineering Personnel who will be assigned in the Project.

{ ATTACH COMPANY LETTERHEAD/LOGO }

Attach the required Proposed Organizational Chart for the Contract as stated above.

Submitted by: _____

Designation : _____

Date : _____

{ATTACH COMPANY LETTERHEAD/LOGO}

Qualification of Key Personnel Proposed to be Assigned to the Project

Name of Project: _____

Location of Project: _____

Name of Company: _____

Address of Company: _____

	Project Manager/Engineer	Material Engineer	Foreman	Construction Safety and Health Personnel	Other Position deemed required by the Applicant for this project
1. Name					
2. Address					
3. Date of Birth					
4. Employed Since					
5. Experience					
6. Previous Employment					
7. Education					
8. PRC License					

Note: Attached individual PRC License of the (professional) personnel.

Submitted by : _____
(Signature over Printed Name)

Designation : _____

Date : _____

{ ATTACH COMPANY LETTERHEAD/LOGO }

Date: _____

ROLDAN P. ABEJUELA

Chairman, Bids and Awards Committee
Civil Aviation Authority of the Philippines-Area III
0385 Lumangbayan Plaridel Airport, Plaridel Bulacan
Tel: 044 794 7071

Subject: Contractor's Letter-Certificate to Procuring Entity

Dear Sir:

Supplementing our Organizational Chart for the Contract, we have the honor to submit herewith, and to certify as true and correct, the following pertinent information:

That I/we have engaged the service of _____ (*Name of Employee*), to be the (*Designation*) of the (*Name of Project*), who is a (*Profession*) _____ with Professional License Certificate No. _____ issued on _____ and _____ who has performed the duties in the construction of the project enumerated in the filled Annex -B Form 5b.

That (*Name of Employee*) shall personally perform the duties of the said position in the above-mentioned project, if and when the same is awarded in our favor.

That (*Name of Employee*) shall employ the best care, skill and ability in performing his duties in accordance with the Contract Agreement, Conditions of Contract, Plans, Specifications, Special Provisions, and other provisions embodied in the proposed contract.

That (*Name of Employee*) shall be personally present at the jobsite all the time to supervise the phase of the construction work pertaining to his assignment as (*Designation*).

That (*Name of Employee*) is aware that he shall be authorized to handle only one contract at a time.

That in order to guarantee that(Name of Employee)shall perform his duties properly and be personally present in the Job Site, he is hereby required to secure a certificate of appearance for the Procuring Entity's Engineer at the end of every month.

That in the event that I/we elect or choose to replace(Name of Employee)with another Engineer, the Procuring Entity will be accordingly notified by us in writing at least twenty one(21) days before making replacement. We will submit to the Procuring Entity, for prior approval, the name of the proposed new(Designation), his qualification, experience, list of projects undertaken and other relevant information.

That any willful violation on my/our part of the herein conditions may prejudice my/our standing as a reliable contractor in future bidding of the Procuring Entity.

Very truly yours,

(Authorized Representative of Bidder)

CONCURRED BY:

(Name of Engineer)

{ ATTACH COMPANY LETTERHEAD/LOGO }

Date: _____

ROLDAN P. ABEJUELA

Chairman, Bids and Awards Committee
Civil Aviation Authority of the Philippines-Area III
0385 Lumangbayan Plaridel Airport, Plaridel Bulacan
Tel: 044 794 7071

Subject: Key Personnel's Certificate of Employment

Dear Sir:

I am *(Name of Employee)* a License _____ Engineer with Professional License No. _____ issued on *(Date of Issuance)* at *(Place of Issuance)*.

I hereby certify that *(Name of Bidder)* has engaged my services as *(Designation)* for *(Name of the Project)*, if awarded in their favor.

As *(Designation)*, I know I will have to stay in the job site all the time to supervise and managed the Contract works to the best of my ability, and aware that I am authorized to handle only one (1) contract at a time.

I do not allow the use of my name for the purpose of enabling the above-mentioned Contractor to qualify for the Contract without any firm commitment on my part to assume the post of *(Designation)*.

As *(Designation)*, I supervised the following completed projects similar to the contract under bidding:

NAME OF PROJECT	OWNER	COST	DATE COMPLETED
_____	_____	_____	_____
_____	_____	_____	_____
_____	_____	_____	_____
_____	_____	_____	_____

At present, I am supervising the following project:

NAME OF PROJECT	OWNER	COST	DATE COMPLETION
_____	_____	_____	_____
_____	_____	_____	_____
_____	_____	_____	_____
_____	_____	_____	_____

In case of my separation for any reason whatsoever from the above-mentioned Contractor, I shall notify the *(Name of the Procuring Entity)* at least twenty one (21) days before the effective date of my separation.

(Signature of Engineer)

SUBSCRIBED AND SWORN to before me this ___ day of _____, 20____
 _____ affiant exhibiting to me his/her Residence Certificate No. ___
 _____ issued on _____ at _____
 _____, Philippines.

Notary Public

Until 31 December 20____
 PRT No.: _____
 Issued at: _____
 Issued on: _____
 TIN No.: _____

Doc. No. _____
 Page No. _____
 Book No. _____
 Series of _____

KEY PERSONNEL
(FORMAT OF BIO-DATA)

Give the detailed information of the following personnel who are scheduled to be assigned as full-time field staff for the project. Fill up a form for each person.

1. Authorized Managing Officer /Representative: _____

2. Sustained Technical Employee:

Name: _____

Date of Birth: _____

Nationality: _____

Education and Degrees: _____

Specialty: _____

Registration: _____

Length of Service with the Firm:

_____ Year From _____(months) _____(year)

To _____(months) _____(year)

Years of Experience:

If Item 7 is less than ten (10) years, give name and length of service with previous employers for a ten (10) year period (attached additional sheet/s, if necessary):

Name and Address of Employer Length of Service

_____ year(s) from _____ to _____

_____ year(s) from _____ to _____

_____ year(s) from _____ to _____

Experience:

This should cover the past ten (10) years of experience. (Attached as many ages as necessary to show involvement of personnel in projects using the format below).

- a. Name: _____
- b. Name and Address of Owner: _____
- c. Name and Address of the Owner's Engineer(Consultant): _____
- d. Indicate the Features of Project (particulars of the project components and any other particular interest connected with the project): _____
- e. Contract Amount Expressed in Philippine Currency: _____
- f. Position: _____
- g. Structures for which the employee was responsible: _____
- h. Assignment Period: from _____(months) _____(years)
to _____(months) _____(years)

Name and Signature of Employee

It is hereby certified that the above personnel can be assigned to the _____Project, if the contract is awarded to our company.

(Place and Date)

(The Authorized Representative)

List of Equipment, Owned or Leased and/or under Purchased Agreements, Pledge to the Proposed Project

Name of Project: _____

Location of Project: _____

Name of Company: _____

Address of Company: _____

Description	Model/Year	Capacity/ Performance/ Size	Plate No.	Motor No./ Body No.	Location	Condition	Proof of Ownership/ Lessor or Vendor
<u>A. Owned</u>							
I.							
II.							
III.							
IV.							
V.							
<u>B. Leased</u>							
I.							
II.							
III.							
IV.							
V.							
<u>C. Under Purchased Agreement</u>							
I.							
II.							
III.							
IV.							
V.							

Submitted by : _____
(Signature over Printed Name)

Designation : _____

Date : _____

Omnibus Sworn Statement

REPUBLIC OF THE PHILIPPINES)
CITY/MUNICIPALITY OF _____) S.S.

A F F I D A V I T

I, *[Name of Affiant]*, of legal age, *[Civil Status]*, *[Nationality]*, and residing at *[Address of Affiant]*, after having been duly sworn in accordance with law, do hereby depose and state that:

1. Select one, delete the other:

If a sole proprietorship: I am the sole proprietor or authorized representative of *[Name of Bidder]* with office address at *[address of Bidder]*;

If a partnership, corporation, cooperative, or joint venture: I am the duly authorized and designated representative of *[Name of Bidder]* with office address at *[address of Bidder]*;

2. Select one, delete the other:

If a sole proprietorship: As the owner and sole proprietor or authorized representative of *[Name of Bidder]*, I have full power and authority to do, execute and perform any and all acts necessary to participate, submit the bid, and to sign and execute the ensuing contract for *[Name of the Project]* of the *[Name of the Procuring Entity]* *[insert "as shown in the attached duly notarized Special Power of Attorney" for the authorized representative]*;

If a partnership, corporation, cooperative, or joint venture: I am granted full power and authority to do, execute and perform any and all acts necessary to participate, submit the bid, and to sign and execute the ensuing contract for *[Name of the Project]* of the *[Name of the Procuring Entity]*, accompanied by the duly notarized Special Power of Attorney, Board/Partnership Resolution, or Secretary's Certificate, whichever is applicable;

3. *[Name of Bidder]* is not blacklisted or barred from bidding by the Government of _____ the Philippines or any of its agencies, offices, corporations, or Local Government Units, foreign government/foreign or international financing institution whose blacklisting rules have been recognized by the Government Procurement Policy Board;

4. Each of the documents submitted in satisfaction of the bidding requirements is an authentic copy of the original, complete, and all statements and information provided therein are true and correct;

5. *[Name of Bidder]* is authorizing the Head of the Procuring Entity or its duly authorized representative(s) to verify all the documents submitted;

6. *Select one, delete the rest:*

If a sole proprietorship: The owner or sole proprietor is not related to the Head of the Procuring Entity, members of the Bids and Awards Committee (BAC), the Technical Working Group, and the BAC Secretariat, the head of the Project Management Office or the end-user unit, and the project consultants by consanguinity or affinity up to the third civil degree;

If a partnership or cooperative: None of the officers and members of *[Name of Bidder]* is related to the Head of the Procuring Entity, members of the Bids and Awards Committee (BAC), the Technical Working Group, and the BAC Secretariat, the head of the Project Management Office or the end-user unit, and the project consultants by consanguinity or affinity up to the third civil degree;

If a corporation or joint venture: None of the officers, directors, and controlling stockholders of *[Name of Bidder]* is related to the Head of the Procuring Entity, members of the Bids and Awards Committee (BAC), the Technical Working Group, and the BAC Secretariat, the head of the Project Management Office or the end-user unit, and the project consultants by consanguinity or affinity up to the third civil degree;

7. *[Name of Bidder]* complies with existing labor laws and standards; and

8. *[Name of Bidder]* is aware of and has undertaken the following responsibilities as a Bidder:

a. Carefully examine all of the Bidding Documents;

b. Acknowledge all conditions, local or otherwise, affecting the implementation of the Contract;

c. Made an estimate of the facilities available and needed for the contract to be bid, if any; and

d. Inquire or secure Supplemental/Bid Bulletin(s) issued for the *[Name of the Project]*.

9. *[Name of Bidder]* did not give or pay directly or indirectly, any commission, amount, fee, or any form of consideration, pecuniary or otherwise, to any person or official, personnel or representative of the government in relation to any procurement project or activity.

IN WITNESS WHEREOF, I have hereunto set my hand this ____ day of ____, 20__ at _____, Philippines.

Bidder's Representative/Authorized Signatory

SUBSCRIBED AND SWORN to before me this day of [month] [year] at [place of execution], Philippines. Affiant/s is/are personally known to me and was/were identified by me through competent evidence of identity as defined in the 2004 Rules on Notarial Practice (A.M. No. 02-8-13-SC). Affiant/s exhibited to me his/her [insert type of government identification card used], with his/her photograph and signature appearing thereon, with no. _____ and his/her Community Tax Certificate No. _____ issued on at _____.

Witness my hand and seal this ____ day of [month][year].

NAME OF NOTARY PUBLIC

Serial No. of Commission _____
Notary Public for until _____
Roll of Attorneys No. _____
PTR No. _____ [date issued], [place issued]
IBP No. _____ [date issued], [place issued]

Doc. No.
Page No.
Book No.
Series of _____

* This form will not apply for WB funded projects.

Bid Form

Date: _____

IB²N^o: _____

To: *[name and address of PROCURING ENTITY]*

Address: *[insert address]*

We, the undersigned, declare that:

- (a) We have examined and have no reservation to the Bidding Documents, including Addenda, for the Contract *[insert name of contract]*;
- (b) We offer to execute the Works for this Contract in accordance with the Bid and Bid Data Sheet, General and Special Conditions of Contract accompanying this Bid;

The total price of our Bid, excluding any discounts offered below is: *[insert information]*;

The discounts offered and the methodology for their application are: *[insert information]*;

- (c) Our Bid shall be valid for a period of *[insert number]* days from the date fixed for the Bid submission deadline in accordance with the Bidding Documents, and it shall remain binding upon us and may be accepted at any time before the expiration of that period;
- (d) If our Bid is accepted, we commit to obtain a Performance Security in the amount of *[insert percentage amount]* percent of the Contract Price for the due performance of the Contract;
- (e) Our firm, including any subcontractors or suppliers for any part of the Contract, have nationalities from the following eligible countries: *[insert information]*;
- (f) We are not participating, as Bidders, in more than one Bid in this bidding process, other than alternative offers in accordance with the Bidding Documents;
- (g) Our firm, its affiliates or subsidiaries, including any subcontractors or suppliers for any part of the Contract, has not been declared ineligible by the Funding Source;

² If ADB, JICA and WB funded projects, use IFB.

- (h) We understand that this Bid, together with your written acceptance thereof included in your notification of award, shall constitute a binding contract between us, until a formal Contract is prepared and executed; and
- (i) We understand that you are not bound to accept the Lowest Calculated Bid or any other Bid that you may receive.
- (j) We likewise certify/confirm that the undersigned, is the duly authorized representative of the bidder, and granted full power and authority to do, execute and perform any and all acts necessary to participate, submit the bid, and to sign and execute the ensuing contract for the [Name of Project] of the [Name of the Procuring Entity].**
- (k) We acknowledge that failure to sign each and every page of this Bid Form, including the Bill of Quantities, shall be a ground for the rejection of our bid.**

Name: _____

In the capacity of: _____

Signed: _____

Duly authorized to sign the Bid for and on behalf of: _____

Date: _____

Other Bidding Forms

(ANNEX "C")

Annex "C"Form1	Bill of Quantities
Annex "C"Form2	Summary Bid Proposal
Annex "C"Form3	Bill of Materials & Cost Estimates
Annex "C"Form4	Summary of Unit Prices of Materials
Annex "C"Form5	Summary of Unit Prices of Labor
Annex "C"Form6	Summary of Unit Prices of Equipment
Annex "C"Form7	Cash Flow by Quarter and Payment Schedule

CAAP-BAC-SF Annex "C" Form 1

[ATTACH COMPANY LETTERHEAD/LOGO]

BILL OF QUANTITIES

PROJECT: _____
LOCATION: _

ITEM NO.	DESCRIPTION	QTY	UNIT	UNIT PRICE (Pesos)	AMOUNT (Pesos)
	Pesos _____ Amount in Words _____ _____ and _____ _____ centavos				
	Pesos _____ Amount in Words _____ _____ and _____ _____ centavos				
	Pesos _____ Amount in Words _____ _____ and _____ _____ centavos				
	Pesos _____ Amount in Words _____ _____ and _____ _____ centavos				

TOTAL BID AMOUNT (Php) _____

TOTAL BID AMOUNT IN WORDS _____

Signature: _____
Printed Name: _____
Position: _____
Name Company: _____
Date: _____

{ATTACH COMPANY LETTERHEAD/LOGO}

SUMMARY OF BID PROPOSAL

PROJECT:
LOCATION:

ITEM NO.	DESCRIPTION OF WORK	QTY	UNIT	ESTIMATED DIRECT COST	MARK-UPS IN PERCENT		TOTAL MARK-UP		V.A.T.	TOTAL INDIRECT COST	TOTAL COST	UNIT COST
					OCM	PROFIT	%	VALUE				
[1]	[2]	[3]	[4]	[5]	[6]	[7]	[8]	[9] [5] x [8]	[10] 5%{[5] + [9]}	[11] [9] + [10]	[12] [5] + [11]	[13] [12] / [3]

SUBMITTED BY:
Signature: _____
Printed Name: _____
Position: _____
Name Company: _____
Date: _____

CAAP-BAC-SF Annex "C" Form 3

{ATTACH COMPANY LETTERHEAD/LOGO}

BILLOF MATERIALS & COST ESTIMATES					
NAME OF PROJECT		:			
DESCRIPTION		:			
LOCATION		:			
				QUANTITY	UNIT
ITEM	DESCRIPTION	QUANTITY	UNIT	UNIT COST	AMOUNT
A	TOTAL MATERIAL COST				
B	TOTAL LABOR COST				
C	TOTAL EQUIPMENT COST				
D	TOTAL DIRECT COST				
INDIRECT COSTS					
1. OCM (0% of TDC)					
2. CONTRACTOR'S PROFIT (0% of TDC)					
E. TOTAL OCM & CONTRACTOR'S PROFIT					
F. VALUE ADDED TAX, (VAT) 5.0%					
G. TOTAL ESTIMATED INDIRECT COST (E + F), P					
H. TOTAL ESTIMATED UNIT INDIRECT COST (G / Quantity), P/Unit					
TOTAL ESTIMATED COST (D + G), P					
TOTAL ESTIMATED UNIT COST (Total Estimated Cost / Quantity), P/Unit					

SUBMITTED BY:

Signature: _____

Printed Name: _____

Position: _____

Name Company: _____

Date: _____

{ATTACH COMPANY LETTERHEAD/LOGO}

SUMMARY FOR UNIT PRICES OF MATERIALS

PROJECT: _____

LOCATION: _____

DESCRIPTION	UNIT PRICE	UNIT

SUBMITTED BY:

Signature: _____

Printed Name: _____

Position: _____

Name Company: _____

Date: _____

{ATTACH COMPANY LETTERHEAD/LOGO}

SUMMARY FOR UNIT PRICES OF LABOR

PROJECT: _____

LOCATION: _____

DESCRIPTION	UNIT PRICE	UNIT

SUBMITTED BY:

Signature: _____

Printed Name: _____

Position: _____

Name Company: _____

Date: _____

{ATTACH COMPANY LETTERHEAD/LOGO}

SUMMARY FOR UNIT PRICES OF EQUIPMENT

PROJECT: _____

LOCATION: _____

DESCRIPTION	UNIT PRICE	UNIT

SUBMITTED BY:

Signature: _____

Printed Name: _____

Position: _____

Name Company: _____

Date: _____

{ ATTACH COMPANY LETTERHEAD/LOGO }

Name of Project : _____

Location of Project : _____

CASH FLOW BY QUARTER AND PAYMENT SCHEDULE

PARTICULAR	% W	1ST QUARTER	2ND QUARTER	3RD QUARTER	4TH QUARTER
ACCOMPLISHMENT					
CASH FLOW					
CUMULATIVE ACCOMPLISHMENT					
CUMULATIVE CASH FLOW					

Submitted by:

Name of the Representative of the Bidder

Position

Name of the Company

Date

Other Bidding Forms

(ANNEX “D”)

Annex “D”Form1..... Authority of Signatory (Secretary's Certificate)

**AUTHORITY OF SIGNATORY
(SECRETARY'S CERTIFICATE)**

I, a duly elected and qualified Corporate Secretary of (Name of the Bidder), a corporation duly organized and existing under and by virtue of the law of the, DO HEREBY CERTIFY, that:

I am familiar with the facts herein certified and duly authorized to certify the same;

At the regular meeting of the Board of Directors of the said Corporation duly convened and held on at which meeting a quorum was present and acting throughout, the following resolutions were approved, and the same have been annulled, revoked and amended in any way whatever and are in full force and effect on the date hereof:

RESOLVED, that (Name of Bidder) be, as it hereby is, authorized to participate in the bidding of (Name of the Project) by the (Name of the Procuring Entity); and in that if awarded the project shall enter into a contract with the (Name of the Procuring Entity) and in connection therewith hereby appoints (Name of Representative), acting as duly authorized and designated representatives of (Name of the Bidder), and granted full power and authority to do, execute and perform any and all acts necessary and/or to represent (Name of the Bidder) in the bidding as fully and effectively as the (Name of the Bidder) might do if personally present with full power of substitution and revocation and hereby satisfying and confirming all that my said representative shall lawfully do or cause to be done by virtue hereof;

RESOLVED FURTHER THAT, the Board hereby authorized its President
to:

- a. execute a waiver of jurisdiction whereby the (Name of the Bidder) hereby submits itself to the jurisdiction of the Philippine government and hereby waives its right to question the jurisdiction of the Philippine court;
- b. execute a waiver that the (Name of the Bidder) shall not seek and obtain writ of injunctions or prohibition or restraining order against the CAAP or any other agency in connection with this Project to prevent and restrain the bidding procedures related thereto, the negotiating and award of a contract to a successful bidder, and the carrying out of the awarded project.

WITNESS the signature of the undersigned as such officer of the said this.

(Corporate Secretary)

SUBSCRIBED AND SWORN to before me this day of, _____20__ affiant
exhibited to me his/her Community Tax Certificate No. ____ issued on _____
_____At Philippines.

Notary Public

Until 31December20__

PRT No.: _____

Issued at: _____

Issued on: _____

TIN No.: _____

Doc. No. _____

Page No.: _____

Book No.: _____

Series of _____

Section X. Checklist of Technical and Financial Documents

Notes on the Checklist of Technical and Financial Documents

The prescribed documents in the checklist are mandatory to be submitted in the Bid, but shall be subject to the following:

- a. GPPB Resolution No. 09-2020 on the efficient procurement measures during a State of Calamity or other similar issuances that shall allow the use of alternate documents in lieu of the mandated requirements; or
- b. any subsequent GPPB issuances adjusting the documentary requirements after the effectivity of the adoption of the PBDs.

The BAC shall be checking the submitted documents of each Bidder against this checklist to ascertain if they are all present, using a non-discretionary “pass/fail” criterion pursuant to Section 30 of the 2016 revised IRR of RA No. 9184.

Checklist of Technical and Financial Documents

I. TECHNICAL COMPONENT ENVELOPE

Class “A” Documents

Legal Documents

- (a) Valid PhilGEPS Registration Certificate (Platinum Membership) (all pages);
or
- (b) Registration certificate from Securities and Exchange Commission (SEC), Department of Trade and Industry (DTI) for sole proprietorship, or Cooperative Development Authority (CDA) for cooperatives or its equivalent document;
and
- (c) Mayor’s or Business permit issued by the city or municipality where the principal place of business of the prospective bidder is located, or the equivalent document for Exclusive Economic Zones or Areas;
and
- (e) Tax clearance per E.O. No. 398, s. 2005, as finally reviewed and approved by the Bureau of Internal Revenue (BIR).

Technical Documents

- (f) Statement of the prospective bidder of all its ongoing government and private contracts, including contracts awarded but not yet started, if any, whether similar or not similar in nature and complexity to the contract to be bid; **and**
- (g) Statement of the bidder’s Single Largest Completed Contract (SLCC) similar to the contract to be bid, except under conditions provided under the rules; **and**
- (h) Philippine Contractors Accreditation Board (PCAB) License;
or
Special PCAB License in case of Joint Ventures;
and registration for the type and cost of the contract to be bid; **and**
- (i) Original copy of Bid Security. If in the form of a Surety Bond, submit also a certification issued by the Insurance Commission;
or
Original copy of Notarized Bid Securing Declaration; **and**
- (j) Project Requirements, which shall include the following:
 - a. Organizational chart for the contract to be bid;
 - b. List of contractor’s key personnel (*e.g.*, Project Manager, Project Engineers, Materials Engineers, and Foremen), to be assigned to the contract to be bid, with their complete qualification and experience data;
 - c. List of contractor’s major equipment units, which are owned, leased, and/or under purchase agreements, supported by proof of ownership or certification of availability of equipment from the equipment lessor/vendor for the duration of the project, as the case may be; **and**
- (k) Original duly signed Omnibus Sworn Statement (OSS);
and if applicable, Original Notarized Secretary’s Certificate in case of a

corporation, partnership, or cooperative; or Original Special Power of Attorney of all members of the joint venture giving full power and authority to its officer to sign the OSS and do acts to represent the Bidder.

Financial Documents

- (l) The prospective bidder's audited financial statements, showing, among others, the prospective bidder's total and current assets and liabilities, stamped "received" by the BIR or its duly accredited and authorized institutions, for the preceding calendar year which should not be earlier than two (2) years from the date of bid submission; **and**
- (m) The prospective bidder's computation of Net Financial Contracting Capacity (NFCC).

Class "B" Documents

- (n) If applicable, duly signed joint venture agreement (JVA) in accordance with RA No. 4566 and its IRR in case the joint venture is already in existence;
or
duly notarized statements from all the potential joint venture partners stating that they will enter into and abide by the provisions of the JVA in the instance that the bid is successful.

II. FINANCIAL COMPONENT ENVELOPE

- (o) Original of duly signed and accomplished Financial Bid Form; **and**

Other documentary requirements under RA No. 9184

- (p) Original of duly signed Bid Prices in the Bill of Quantities; **and**
- (q) Duly accomplished Detailed Estimates Form, including a summary sheet indicating the unit prices of construction materials, labor rates, and equipment rentals used in coming up with the Bid; **and**
- (r) Cash Flow by Quarter.
- (s) Summary Sheet indicating the Unit Prices of Construction Materials, Labor Rates, and Equipment Rentals used in coming up with the Bid (*Annex "C Form 4, 5 & 6*); **and**
- (t) Cash Flow by Quarter and Payment Schedule (*Annex "C" Form 7*).

