



**BID BULLETIN NO. 02**  
**CILO 2022-015**  
October 5, 2022

**Bid Bulletin No. 02 CILO 2022-015** (to be enclosed in the Technical Component) is hereby issued for the information of Prospective Bidders relative to the bidding for the project **CONSTRUCTION OF GUARD POST (VARIOUS ELEVATION) AT ILOILO INTERNATIONAL AIRPORT.**

- A. The attached Lay-out will form part of the Bidding Documents:
- B. All sealed envelopes must contain the Mode of Procurement: **COMPETITIVE BIDDING** for the project. Failure to comply with this requirement will be a ground for disqualification.
- C. The CAAP-BAC reserves the right to reject any or all bids, to waive defects or formality therein and to accept bids considered responsive and most advantageous to the Government.

  
ATTY. FRANCES SHANELLE SALINAS  
BAC Chairman

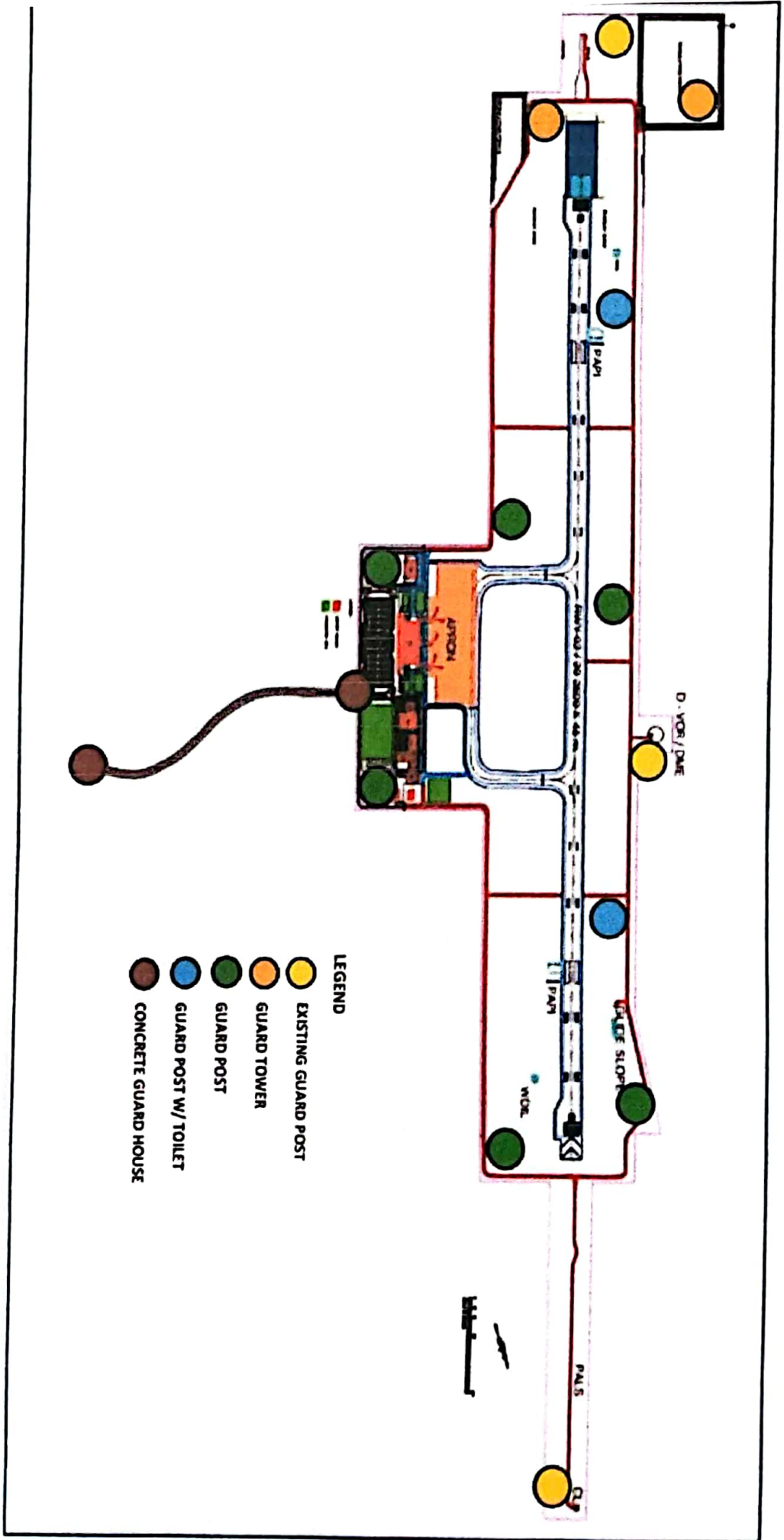

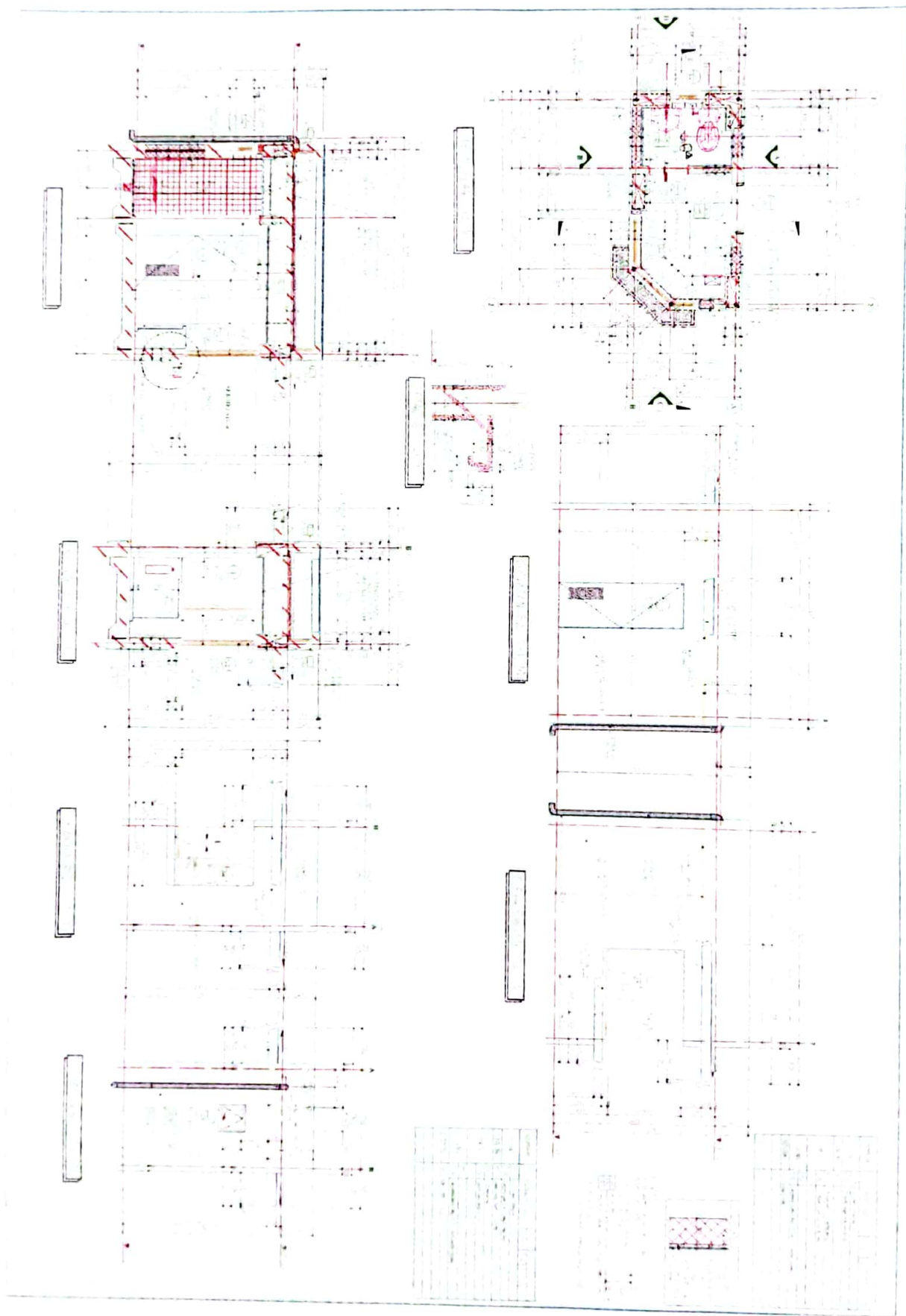

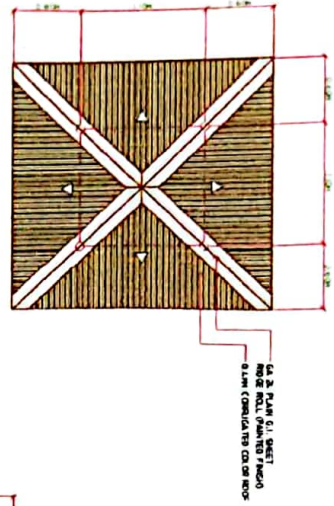

13 ROOF FRAMING PLAN  
1:25 MTS SCALE

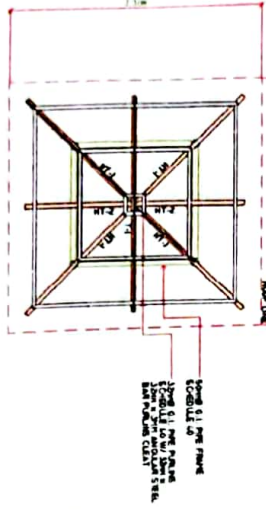

12 ROOF FRAMING PLAN  
1:25 MTS SCALE

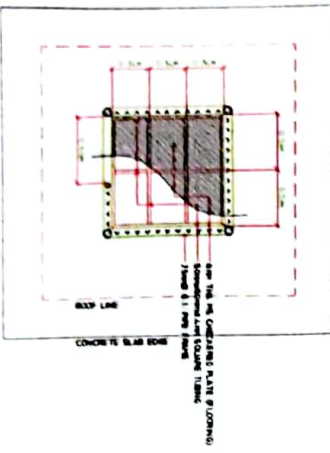

11 FLOOR FRAMING PLAN  
1:25 MTS SCALE

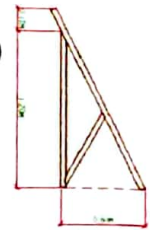

18 HT-1  
1:25 MTS SCALE

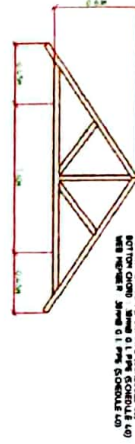

17 T-1  
1:25 MTS SCALE

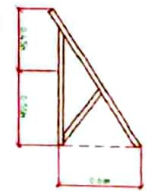

19 HT-2  
1:25 MTS SCALE

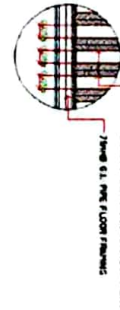

20 DETAIL CONNECTION  
1:25 MTS SCALE

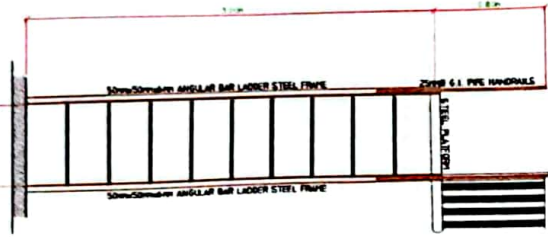

14 STEEL LADDER  
1:25 MTS SCALE

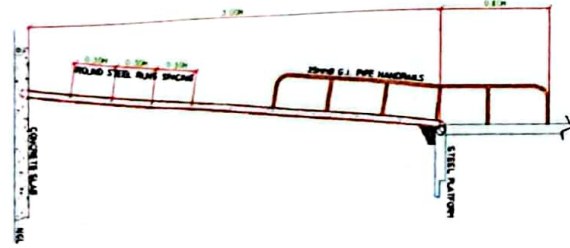

15 SECTION OF STEEL LADDER  
1:25 MTS SCALE

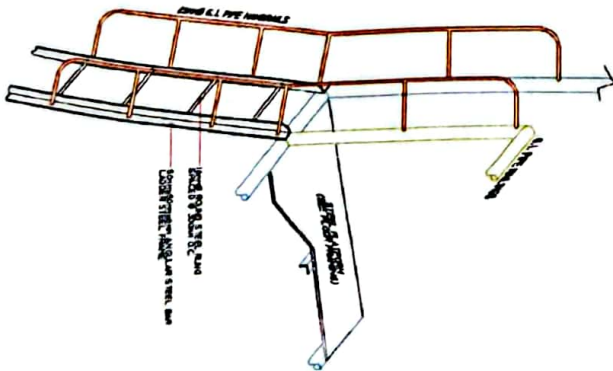

16 ISOMETRIC  
1:25 MTS SCALE



CONSTRUCTION AUTHORITY OF THE PHILIPPINES

THIS DRAWING IS EXCLUSIVE PROPERTY OF CONE AND PARTNER ARCHITECTS AND ENGINEERS. IT IS NOT TO BE REPRODUCED, COPIED, OR USED IN ANY MANNER WITHOUT THE WRITTEN PERMISSION OF CONE AND PARTNER ARCHITECTS AND ENGINEERS.

AEROPORQUE DEVELOPMENT AND MANAGEMENT SERVICE

INFRASTRUCTURE DEVELOPMENT AND DESIGN DIVISION

DESIGN STAFF	ARCHITECTS
ENGINEER	STRUCTURAL
MECHANICAL	ELECTRICAL
PLUMBING	HAZARDOUS WASTE
ENVIRONMENTAL	LANDSCAPE ARCHITECTURE
CONSTRUCTION	CONSTRUCTION MANAGEMENT
OPERATIONS	OPERATIONS
MAINTENANCE	MAINTENANCE
TRAINING	TRAINING
RESEARCH	RESEARCH
QUALITY CONTROL	QUALITY CONTROL
SALES	SALES
MARKETING	MARKETING
FINANCE	FINANCE
LEGAL	LEGAL
GENERAL SERVICES	GENERAL SERVICES
OTHER	OTHER

DRAWN BY

CHECKED BY

APPROVED BY

NOTES/REVISIONS

PROJECT: AIRFIELD GUARD POST  
LOCATION: LILIOLO INTERNATIONAL AIRPORT

SHEET CONTENTS: AS SHOWN

DRAWING SCALE	SHEET NO.	TOTAL SHEETS
AS SHOWN	3	3



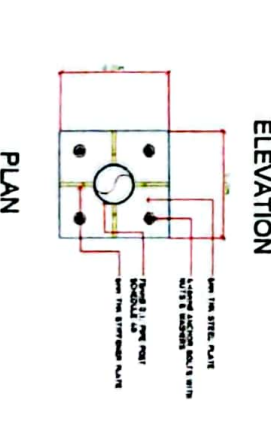
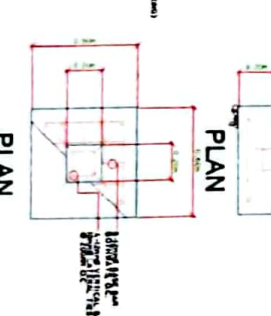
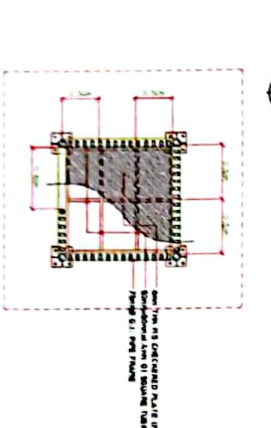
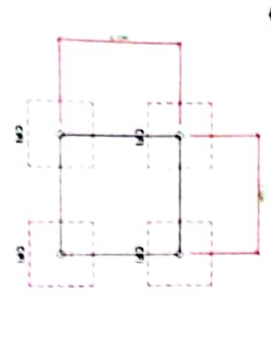
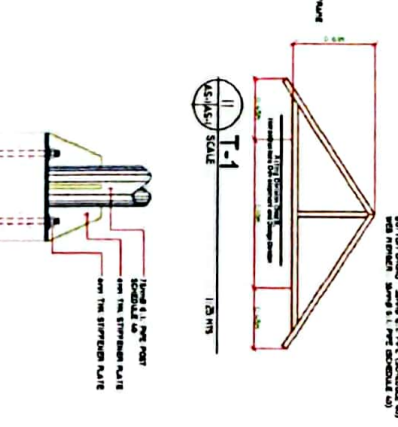
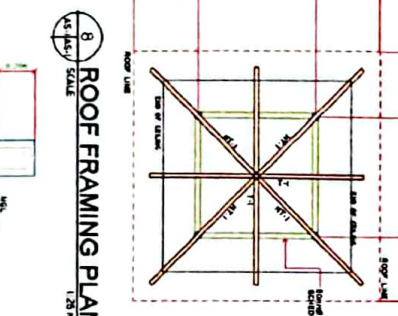
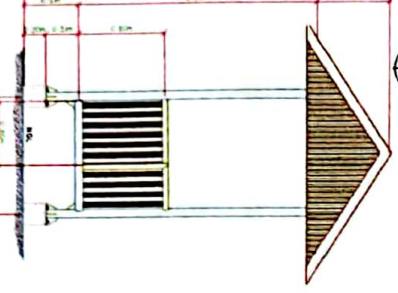
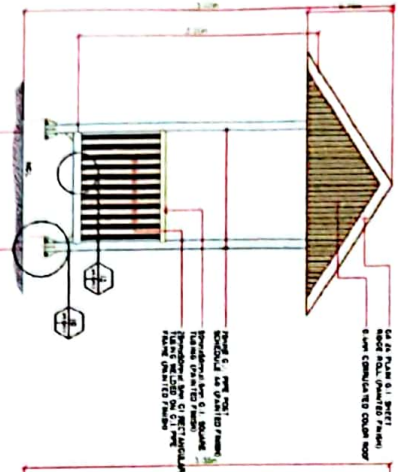
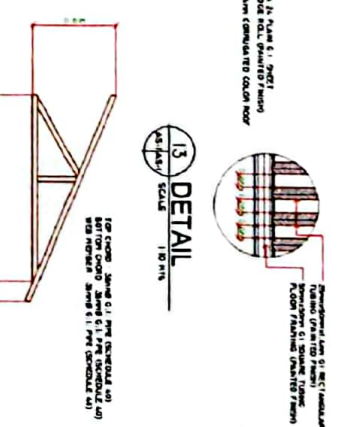
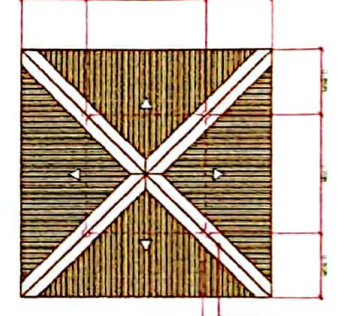
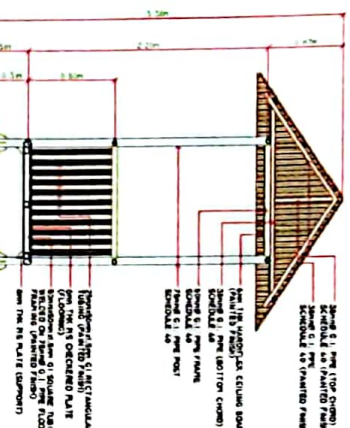
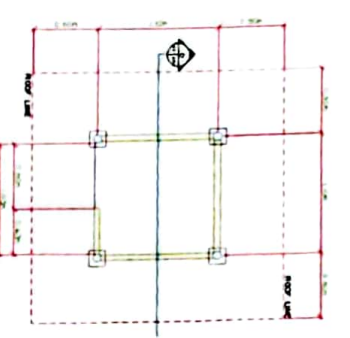

THIS DRAWING IS EXCLUSIVE PROPERTY OF THE CLIENT AND NOT TO BE REPRODUCED, EXCEPT AS AUTHORIZED BY THE CLIENT. ANY REPRODUCTION WITHOUT WRITTEN CONSENT FROM THE DESIGNER, CAM, IS PROHIBITED.

AERONAUTIC DEVELOPMENT AND MANAGEMENT SERVICE

INFRASTRUCTURE DEVELOPMENT AND DESIGN DIVISION

DESIGNED BY	DATE
DRAWN BY	DATE
CHECKED BY	DATE
APPROVED BY	DATE

RECOMMENDED APPROVAL

APPROVED

NOTED/REVISIONS

PROJECT: GUARD POST (TYPE 0)

LOCATION: ILOILO INTERNATIONAL AIRPORT

SHEET CONTENTS: AS SHOWN

PROJECT NO.	AS SHOWN
SHEET NO.	1
TOTAL SHEETS	1